



QS
REGULAR MATRIX

SERVICE MANUAL

4-CHANNEL RECEIVER **SANSUI QRX-5500**



Sansui

SANSUI ELECTRIC CO., LTD.

This service manual is designed for service engineers to repair, adjust, maintain and order the replacement parts of the QRX-5500 correctly.

When ordering the parts, use the stock number and parts name specifically referring to the Parts Locations & Parts List.

For general usage and maintenance of the unit, please refer to the Operating Instructions attached with the unit.

TABLE OF CONTENTS

<u>Section</u>	<u>Title</u>	<u>Page</u>
1.	SPECIFICATIONS	2
2.	BLOCK DIAGRAM AND LEVEL DIAGRAM	3
2-1.	Block Diagram	3, 4
2-2.	Level Diagram	4
3.	ALIGNMENTS AND ADJUSTMENTS	5
3-1.	Regulated Power Supply Board Adjustment	5
3-2.	Level Meter Adjustment	5
3-3.	Driver Circuit Board Adjustment	6
3-4.	FM IF Alignment	7
3-5.	FM Dial Calibration and RF Alignment	7, 8
3-6.	FM Signal Meter, Mono Distortion, Tune Meter and Muting Adjustment	8
3-7.	MPX Alignment	9
3-8.	AM IF, Dial Calibration, RF and Signal Meter Alignment	9, 10
4.	THREADING OF DIAL CORD	11
5.	TROUBLESHOOTING CHART	11
5-1.	Troubleshooting on Power Supply Section	11
5-2.	Troubleshooting on Audio Section	11, 12, 13
5-3.	Troubleshooting on RF Section	13, 14, 15
6.	PARTS LOCATIONS AND PARTS LIST	16
6-1.	F-1472A Equalizer Circuit Board	16
6-2.	F-1487 Volume Circuit Board	16
6-3.	F-1479A Tuner Circuit Board	17, 18, 19
6-4.	F-1489 Mixing & Accessory Circuit Board	19, 20
6-5.	F-2048 Vario-Matrix Circuit Board	21, 22
6-6.	F-2047 Vario-Matrix Circuit Board	23, 24
6-7.	F-1485 Meter Circuit Board	24
6-8.	F-1482 Driver Circuit Board	25, 26, 27
6-9.	F-1483 Protector & Power Circuit Board	27, 28
6-10.	F-1490 De-emphasis Circuit Board	28
6-11.	F-1488 Connector Joint Circuit Board	29
6-12.	F-1486 Filter Circuit Board	29
6-13.	F-1484 Tone Control Circuit Board	30
6-14.	Other Parts (Front Side)	31, 32
6-15.	Other Parts (Top Side)	33
6-16.	Other Parts (Bottom Side)	34
7.	PACKING LIST	35
8.	ACCESSORY PARTS LIST	35
9.	REPLACEMENT OF MAIN PARTS	35
9-1.	Dial Lamp	35
9-2.	How to Install the Knob of DIRECTION Switch	35
10.	SCHEMATIC DIAGRAM OF TUNER SECTION	36
11.	SCHEMATIC DIAGRAM OF AUDIO SECTION	37
12.	MAINTENANCE	38
12-1.	Voltage Adjustment	38

1. SPECIFICATIONS

AUDIO SECTION

POWER OUTPUT (at rated distortion)
 MUSIC POWER (IHF) .. 220W (4 Ω 1,000Hz)
 160W (8 Ω 1,000Hz)
 CONTINUOUS POWER (each channel driven)
 45W/ch. (4 Ω 1,000Hz)
 30W/ch. (8 Ω 1,000Hz)
 CONTINUOUS POWER (4-channels driven)
 25W \times 4 (8 Ω 1,000Hz)
 22W \times 4 (8 Ω 20 to 20,000Hz)
 TOTAL HARMONIC DISTORTION (at rated output)
 OVERALL (from 4-channels AUX) .. less than 0.3%
 INTERMODULATION DISTORTION (at rated output
 70Hz: 7,000Hz=4 : 1 SMPTE method)
 OVERALL (from 4-channels AUX) .. less than 0.3%
 POWER BANDWIDTH (IHF) .. 10 to 30,000Hz
 LOAD IMPEDANCE .. 4 to 16 Ω
 DAMPING FACTOR .. 40 (8 Ω)
 INPUT SENSITIVITY AND IMPEDANCE (1,000Hz for
 rated output)
 PHONO-1, 2 (2-channel) 2.5mV 50k Ω
 Max. input capability
 more than 250mV at 0.5% distortion
 MIC 2.5mV 10k Ω
 AUX (2-ch, 4-ch) 100mV 50k Ω
 TAPE MONITOR (PIN, 2-ch, 4-ch) .. 100mV 50k Ω
 TAPE MONITOR (DIN, 2-ch) 100mV 50k Ω
 RECORDING OUTPUT
 TAPE REC (PIN, 2-ch, 4-ch) 100mV
 TAPE REC (DIN, 2-ch) 30mV
 FREQUENCY RESPONSE (at 1W output)
 OVERALL (from 4-channels AUX)
 30 to 30,000Hz $\pm_{-1.5}^{+1.0}$ dB
 EQUALIZATION (RIAA CURVE)
 30 to 15,000Hz ± 1.0 dB
 CROSSTALK (2-channel) better than 50dB at 1,000Hz
 HUM AND NOISE (IHF)
 PHONO-1, 2 (2-channel) .. better than 70dB
 AUX (4-channels) better than 80dB
 CONTROLS
 BASS ± 12 dB at 50Hz
 TREBLE ± 12 dB at 15,000Hz
 LOUDNESS (volume control at -30 dB)
 $+8$ dB at 50Hz
 $+3$ dB at 10,000Hz
 LOW FILTER -10 dB at 50Hz (6dB/oct.)
 HIGH FILTER -10 dB at 10,000Hz (6dB/oct.)
 4-CHANNEL SYNTHESIZER/DECODER CIRCUIT
 QS regular matrix system with
 QS vario-matrix circuit

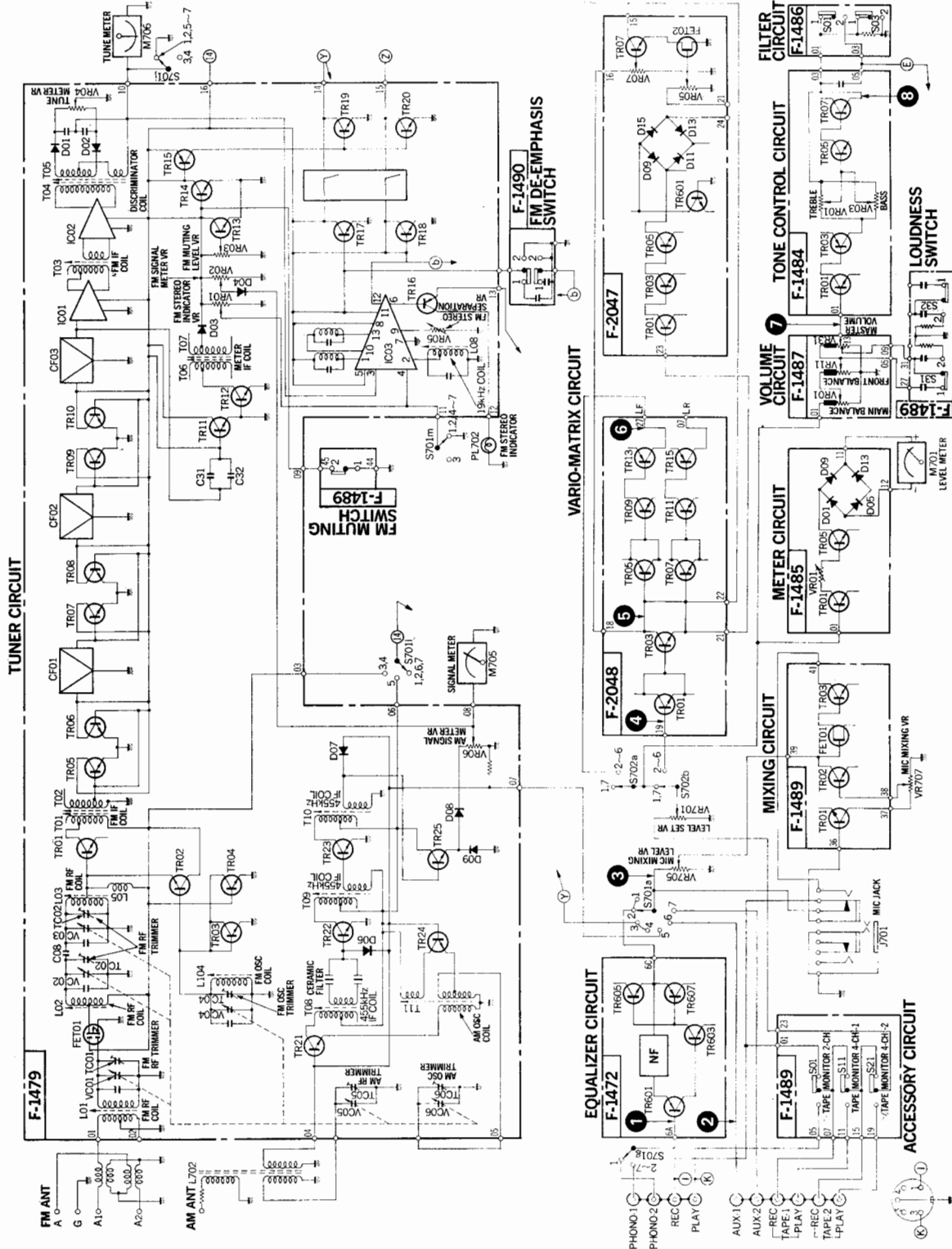
TUNER SECTION

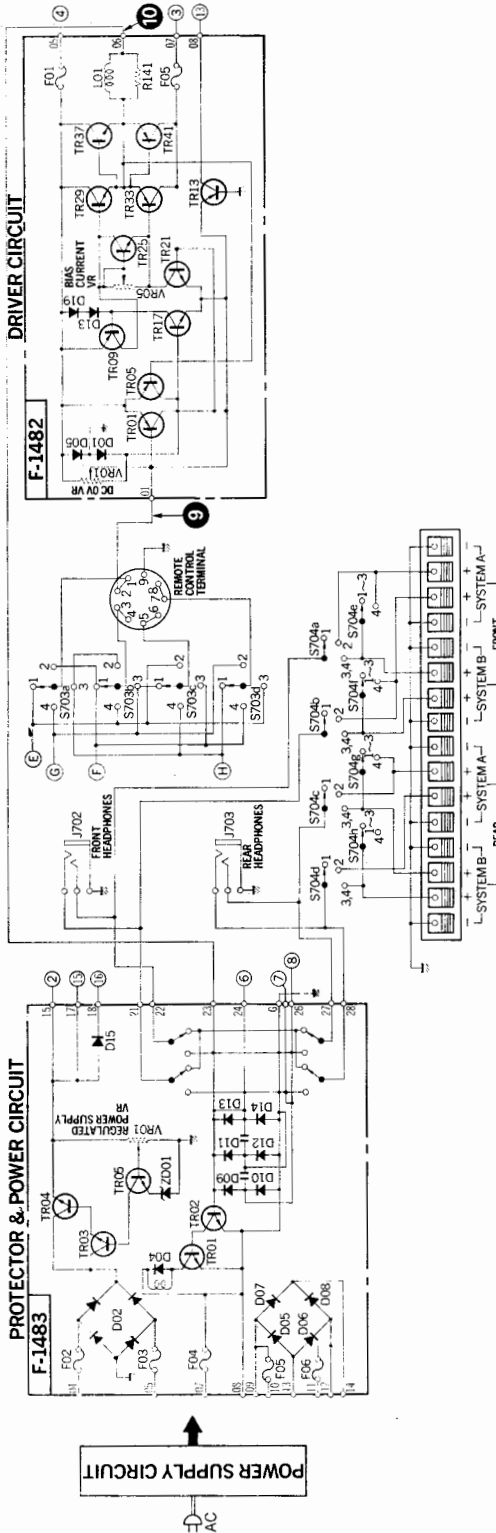
<FM>
 TUNING RANGE 88 to 108MHz
 SENSITIVITY (IHF) 1.9 μ V
 Max. input capability .. more than 120dB
 SIGNAL TO NOISE RATIO (MONO)
 better than 65dB
 CAPTURE RATIO (IHF) less than 2.0dB
 IMAGE REJECTION better than 75dB at 98MHz
 IF REJECTION better than 90dB at 98MHz
 SPURIOUS RESPONSE REJECTION
 better than 80dB at 98MHz
 SELECTIVITY better than 60dB
 TOTAL HARMONIC DISTORTION
 MONO less than 0.3%
 STEREO less than 0.5%
 STEREO SEPARATION better than 37dB at 1,000Hz
 FREQUENCY RESPONSE .. 30 to 15,000Hz $\pm_{-3.0}^{+1.0}$ dB
 ANTENNA IMPEDANCE .. 300 Ω balanced,
 75 Ω unbalanced
 <AM>
 TUNING RANGE 535 to 1605kHz
 SENSITIVITY (bar antenna)
 50dB/m at 1,000kHz
 IMAGE REJECTION better than 80dB/m at 1,000kHz
 IF REJECTION better than 80dB/m at 1,000kHz
 SELECTIVITY better than 25dB at 1,000kHz
 OTHERS
 SEMICONDUCTORS
 TRANSISTORS 136
 FETs 5
 DIODES 80
 ZENER DIODES 6
 ICs 3
 POWER REQUIREMENTS
 VOLTAGE 100V, 117V, 220V, 240V 50/60Hz
 CONSUMPTION 140W (rated), 400VA (max.)
 DIMENSIONS 203mm (8")H, 594mm (23 $\frac{3}{8}$ ")W,
 370mm (14 $\frac{9}{16}$ ")D
 WEIGHT 21.6kg (47.5 lbs) net,
 24.8kg (54.6 lbs) shipping

* Design and specifications subject to change without notice for improvements.

2. BLOCK DIAGRAM AND LEVEL DIAGRAM

2-1. Block Diagram





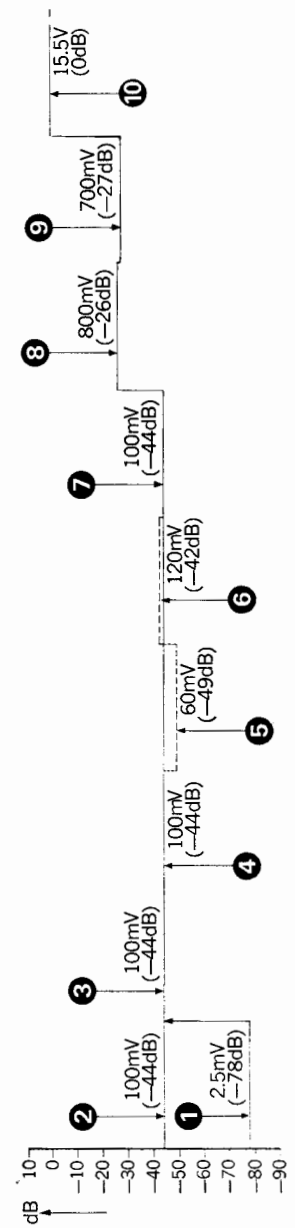
- S01-04: TAPE MONITOR** 2-CH
1. OFF
2. ON
- S01, 02: LOW FILTER**
1. OFF
2. ON
- S03, 04: HIGH FILTER**
1. OFF
2. ON
- S01, 02: FM DE-EMPHASIS**
1. 75µs
2. 50µs
- S21-24: TAPE MONITOR**
4-CH-2
1. OFF
2. ON
- S31-34: TAPE MONITOR**
4-CH-1
1. OFF
2. ON
- S41 : FM MUTING**
1. OFF
2. ON
- S701a-S701o : SELECTOR**
1. PHONO-2
2. PHONO-1
3. FM AUTO
4. FM MONO
5. AM
6. 4-CH AUX-1
7. 4-CH AUX-2
- S702a-S702i : FUNCTION**
1. 2-CH
2. QS SYNTHESIZER HALL
3. QS SYNTHESIZER SURROUND
4. QS REGULAR MATRIX HALL
5. QS REGULAR MATRIX SURROUND
6. PHASE-MATRIX
7. DISCRETE
- S703a-S703h : DIRECTION**
1. NORMAL
2. RIGHT QUARTER TURN
3. HALF TURN
4. LEFT QUARTER TURN
- S704a-S704h : SPEAKER**
1. OFF
2. A
3. B
4. A+B

2-2. Level Diagram

* Each number (①, ②, ③....) indicated in Level Diagram undermentioned corresponds to the number in Block Diagram.

1. MASTER VOLUME, LEVEL SET volume control
..... Maximum
2. BASS, TREBLE, BALANCE Volume control
..... Center
3. Input PHONO-1 2.5mV 1kHz Sine Wave
AUX-1 100mV 1kHz Sine Wave
(output impedance of 600Ω at an audio signal oscillator)
4. Output 15.5V (30W) 8Ω

Note: Each voltage value is for reference and measured by a VTVM. In some recorders, the actual voltage value is in minor difference from the reference value.



3. ALIGNMENTS AND ADJUSTMENTS

Abbreviation

Equipment

AM FM Generator Oscilloscope.....Genescope
 AM Standard Signal GeneratorAM SSG
 FM Standard Signal GeneratorFM SSG
 FM Stereo Generator.....Stereo SG
 OscilloscopeScope
 Audio OscillatorAudio Osci.
 Distortion MeterDist. Meter

Others

ClockwiseCW.
 Counterclockwise.....CCW.
 AntennaANT.
 Modulation.....MOD.

3-1. Regulated Power Supply Board Adjustment (See Fig. 3-1)

Note: 1. Function.....QS Synthesizer
 2. Master Volume.....Minimum
 3. Confirm the AC Power Supply voltage.

STEP	SUBJECT	EQUIPMENT	MEASURE OUTPUT	ADJUST	ADJUST FOR	CONDITION
1	Regulated Power Supply	DC volt meter	F-1483 terminal 18	F-1483 VR01	25±0.1V	

3-2. Level Meter Adjustment (See Fig. 3-2)

Note: 1. FunctionDiscrete
 2. Selector.....AUX-1
 3. Master VolumeMinimum
 4. Level Set VolumeMaximum
 5. For adjustment, run the unit for more than 2 minutes after the power is switched on.

STEP	SUBJECT	FEED SIGNAL		MEASURE OUTPUT	ADJUST	ADJUST FOR	CONDITION
		FROM	TO				
1	Level Meter	1kHz Output : 100mV Audio Osci.	FRONT, REAR AUX-1 L, R-ch	Level Meter	F-1485 VR01 (front L-ch) VR02 (front R-ch) VR03 (rear L-ch) VR04 (rear R-ch)	0 level	○ Feed signal to 4-CH (both FRONT and REAR)

Fig. 3-1

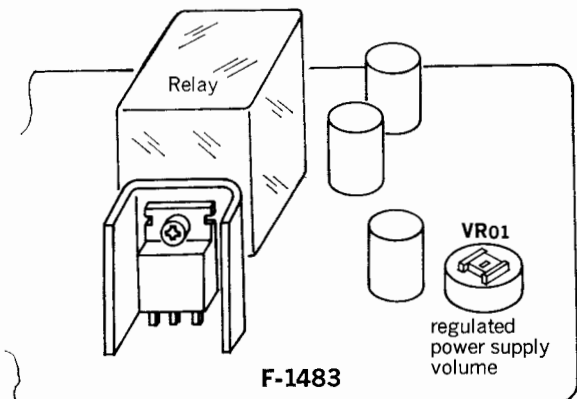
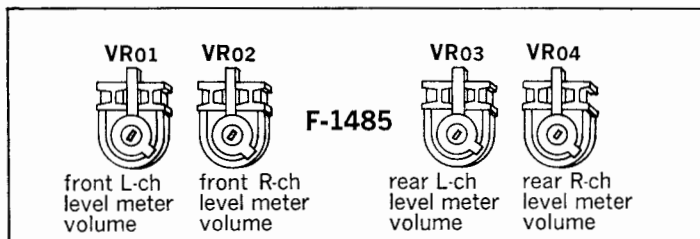


Fig. 3-2



3-3. Driver Circuit Board Adjustment (See Figs. 3-3 and 3-4)

- Note:** 1. Master Volume.....Minimum
 2. Make the SP terminals free (no load).
 3. Confirm the AC Power Supply voltage.
 4. After adjustment, run the unit for more than 5 minutes, then check and readjust necessary.
 5. Room temperature should be 18~28° (65~83°F) for bias current adjustment.

STEP	SUBJECT	EQUIPMENT	MEASURE OUTPUT	ADJUST	ADJUST FOR	CONDITION
1	DC 0V Front L	DC volt meter	Speaker terminal Front L-ch Fig. 3-4	F-1482 VR01	0V	○ Step down meter's range accordingly
2	DC 0V Front R	Same as above	Speaker terminal Front R-ch Fig. 3-4	F-1482 VR02	Same as above	Same as above
3	DC 0V Rear L	Same as above	Speaker terminal Rear L-ch Fig. 3-4	F-1482 VR03	Same as above	Same as above
4	DC 0V Rear R	Same as above	Speaker terminal Rear R-ch Fig. 3-4	F-1482 VR04	Same as above	Same as above
5	Bias current Front L	DC milliammeter	F-1482 F01 Fig. 3-3	F-1482 VR05	25±1mA	○ Step down meter's range accordingly
6	Bias current Front R	Same as above	F-1482 F02 Fig. 3-3	F-1482 VR06	Same as above	Same as above
7	Bias current Rear L	Same as above	F-1482 F03 Fig. 3-3	F-1482 VR07	Same as above	Same as above
8	Bias current Rear R	Same as above	F-1482 F04 Fig. 3-3	F-1482 VR08	Same as above	Same as above

Fig. 3-3

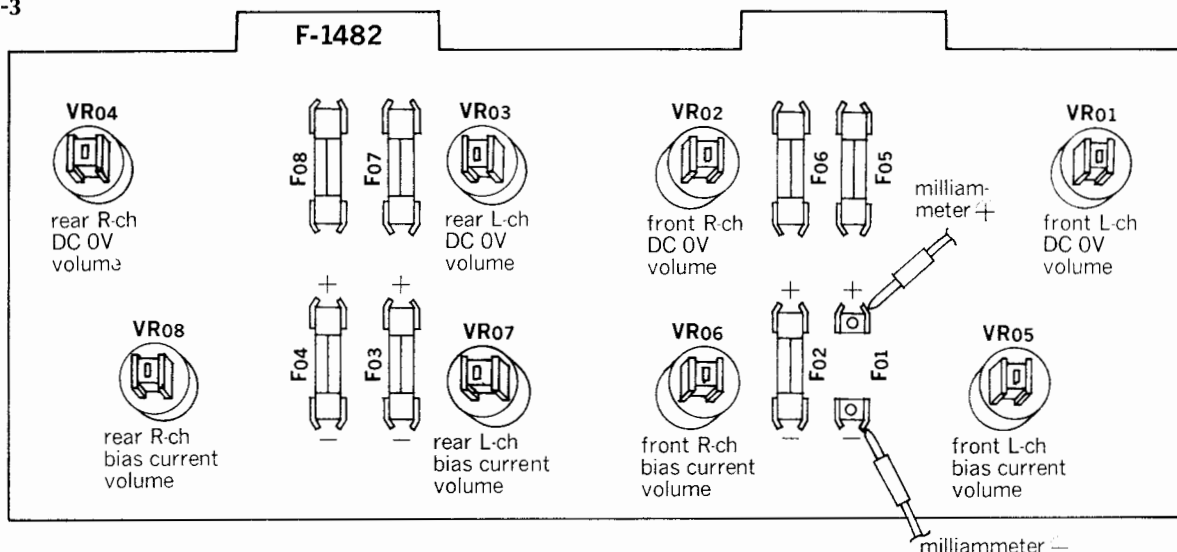
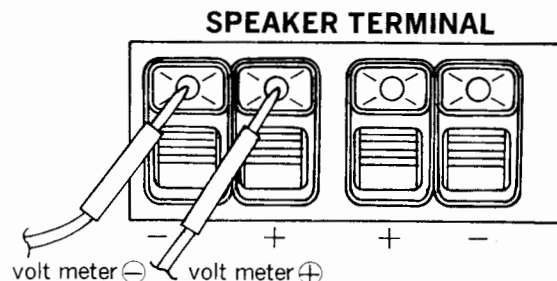


Fig. 3-4

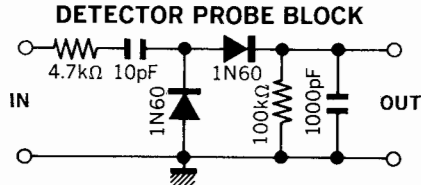
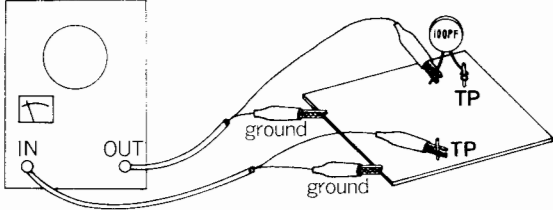


3-4. FM IF Alignment (See Fig. 3-10 on page 10)

- Note:** 1. Selector.....FM AUTO
 2. Master VolumeMinimum
 3. Output lever of genescopesAfter attenuator
 4. Sweepwidth.....1.5~2cm/150kHz
 5. Frequency band9.5~11.5MHz

6. ConnectionConnect the output of genescopes to TP.A through 100p ceramic capacitor.
 7. Before adjustment, turn both VR01 and VR02 CCW (Max.), VR03 CW (Max.) and VR04 to center.

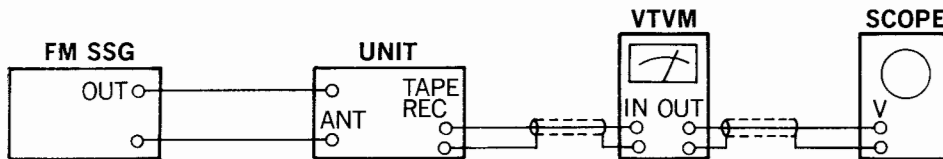
GENE SCOPE



STEP	SUBJECT	FEED SIGNAL		MEASURE OUTPUT	ADJUST	ADJUST FOR	CONDITION
		FROM	TO				
1	IF coil	Output 55dB Genescopes	Base of TR01 on F-1479 (Fig. 3-10 TP.A)	Connected Point between R48 & R50 on F-1479 (Fig. 3-10 TP.B)	T01, T02	Max. IF waveform 1 as Fig. 3-9	Turn core of T06 CCW.
2	Meter coil	Same as above	Same as above	Use Detector Probe Connected point between R62 & VR02 on F-1479 (Fig. 3-10 TP.D) Direct from Genescopes	T06, T07	Max. IF waveform 2 Set the center of waveform 2 with waveform 1 as Fig. 3-9	
3	Discriminator coil	Same as above	Same as above	Connected point between R67 & R68 on F-1479 (Fig. 3-10 TP.C) Direct from Genescopes	T04 T05	Max. linearity of S curve Set the center of S curve waveform 1 & 2 as Fig. 3-9	
4	IF coil	Same as above	Same as above	Same as above	T03	Max. noise	

3-5. FM Dial Calibration and RF Alignment (See Fig. 3-10 on page 10)

- Note:** 1. Selector.....FM AUTO
 2. Master VolumeMinimum
 3. FM Muting switchOFF (pushed in)
 4. Confirm start point of dial pointer before alignment.
 5. In Step 3, 4 and 5, 1 and 2 are readjusted, repeat 3, 4 and 5 again.

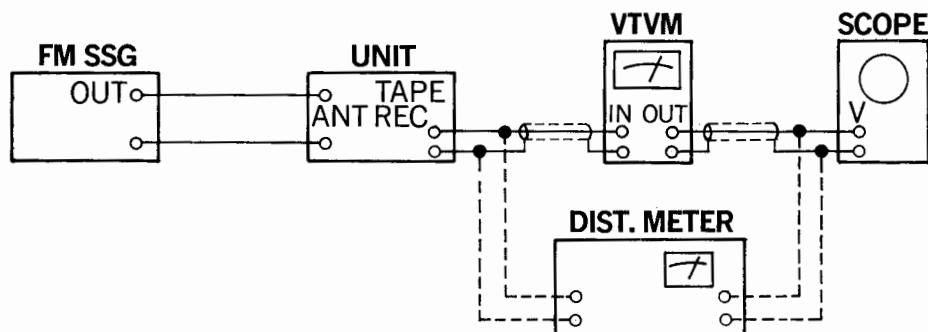


STEP	SUBJECT	FEED SIGNAL		MEASURE OUTPUT	ADJUST	ADJUST FOR	CONDITION
		FROM	TO				
1	88MHz Dial Calibration	88MHz ANT input 60dB 1kHz (100% MOD) FM SSG	ANT terminal 300Ω	REC OUT L or R-ch VTVM & Scope	L04	Max. output	Set Dial on 88MHz
2	108MHz Dial Calibration	108MHz ANT input 60dB 1kHz (100% MOD) FM SSG	Same as above	Same as above	Trimmer Cap. TC04	Same as above	Set Dial on 108MHz

STEP	SUBJECT	FEED SIGNAL		MEASURE OUTPUT	ADJUST	ADJUST FOR	CONDITION
		FROM	TO				
3	Confirm 88MHz Dial Calibration	Same as Step 1	Same as above	Same as above		Confirm 88MHz Dial Calibration	◦If not, repeat from Step 1
4	Confirm 98MHz Dial Calibration	98MHz ANT input 60dB 1kHz (100% MOD) FM SSG	Same as above	Same as above		Confirm 98MHz Dial Calibration	
5	Confirm 108MHz Dial Calibration	Same as Step 2	Same as above	Same as above		Confirm 108MHz Dial Calibration	◦If not, repeat from Step 2
6	88MHz RF Adj.	88MHz ANT input 10dB 1kHz (100% MOD) FM SSG	Same as above	Same as above	L01, L02, L03	Max. output	◦Tune FM SSG (Max. indication of Signal Meter)
7	108MHz RF Adj.	108MHz ANT input 10dB 1kHz (100% MOD) FM SSG	Same as above	Same as above	Trimmer Cap. TC01, TC02, TC03	Same as above	Same as above

3-6. FM Signal Meter, Mono Distortion, Tune Meter and Muting Adjustment (See Fig. 3-10 on page 10)

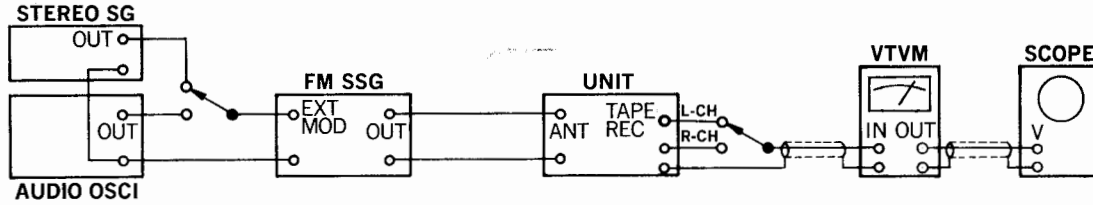
- Note: 1. Selector.....FM AUTO
2. Master VolumeMinimum



STEP	SUBJECT	FEED SIGNAL		MEASURE OUTPUT	ADJUST	ADJUST FOR	CONDITION
		FROM	TO				
1	Signal Meter	98MHz ANT input 66dB 1kHz (100% MOD) FM SSG	ANT terminal 300Ω	Signal Meter	VR02	4.3 on meter 	◦Tune FM SSG (Max. indication of Signal Meter) ◦Before adjustment, if meter swings out or not enough, preadjust VR02 until the reasonable point
2	Distortion	Same as above	Same as above	REC OUT L or R-ch Dist. meter & Scope	T05	Min. distortion	◦Set VR04 to center ◦Tune FM SSG (Max. indication of Signal Meter)
3	Tune Meter			Tune Meter	VR04	Center on Tune meter 	◦Tune interstation noise
4	Muting Level	98MHz ANT input 25dB 1kHz (100% MOD) FM SSG	Same as above	REC OUT L or R-ch VTVM & Scope	VR03	Audio signal just muted 	◦Set FM MUTING switch to OFF (pushed in) ◦Tune the Tune Meter to center and set the muting switch to ON (pushed out)

3-7. MPX Alignment (See Fig. 3-10 on page 10)

- Note:** 1. SelectorFM AUTO
 2. Master Volume.....Minimum
 3. FM MUTING switchOFF (pushed in)
 4. Before adjustment, turn VR01 CW (Max.) and VR05 to center.

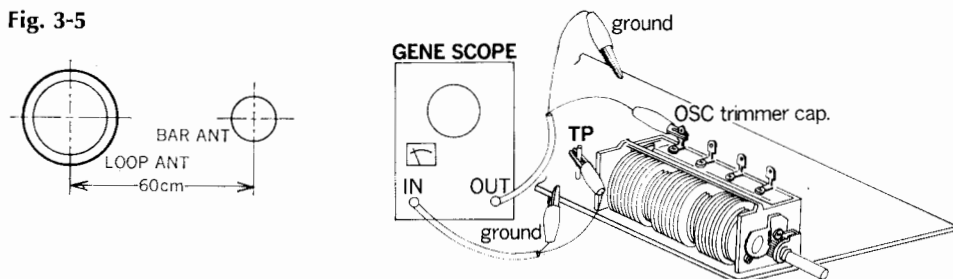


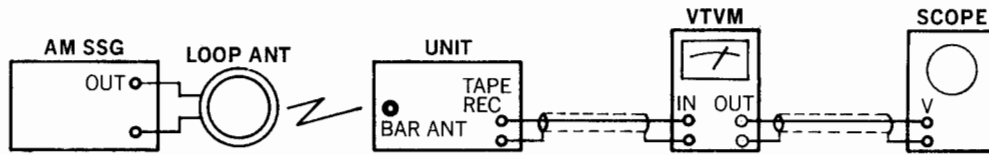
STEP	SUBJECT	FEED SIGNAL		MEASURE OUTPUT	ADJUST	ADJUST FOR	CONDITION
		FROM	TO				
1	19kHz coil	98MHz ANT input 60dB FM SSG Pilot 19kHz (10% MOD) L-ch 1kHz (45% MOD) R-ch (0% MOD) Stereo SG	ANT terminal 300Ω	REC OUT L-ch VTVM & Scope	108	Max. output	○ Tune FM SSG (Center indication of Tune Meter)
2	Separation	Same as above	Same as above	REC OUT R-ch VTVM & Scope	VR05	Min. output	
3	Cofirm Separation	98MHz ANT input 60dB FM SSG Pilot 19kHz (10% MOD) L-ch (0% MOD) R-ch 1kHz (45% MOD) Stereo SG	Same as above	REC OUT L-ch VTVM & Scope		Min. output	○ If less the 37dB adjust VR05
4	Indicator (Lighting level)	98MHz ANT input 31dB FM SSG Pilot 19kHz (10% MOD) Stereo SG	Same as above	Stereo indicator lamp	VR01	Lighting Point	○ Tune FM SSG (Center indication of Tune Meter)

3-8. AM IF, Dial Calibration, RF and Signal Meter Alignment (See Figs. 3-6, 3-7, 3-8 and 3-10 on page 10)

- Note:** 1. Selector.....AM
 2. Master VolumeMinimum
 3. Confirm start point of dial pointer before alignment.
 4. In case of using loop antenna, increase output of AM SSG for 26dB than bar antenna's direct input as it attenuates input sensitivity for 26dB. (See Fig. 3-5)
 5. After adjustment of signal meter, confirm the meter's swing on FM. (If meter swang out or not enough, readjust VR02.) (See Page 3-8)

Fig. 3-5





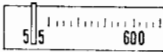


STEP	SUBJECT	FEED SIGNAL		MEASURE OUTPUT	ADJUST	ADJUST FOR	CONDITION
		FROM	TO				
1	IF coil	Output 70dB Genescope	OSC trimmer cap. (TC06) Fig. 3-10	Connected Point between R130 & R136 on F-1479 (Fig. 3-10 TP.E)	T08	Max. IF waveform 1 Fig. 3-6	○ Turn core T09 & T10 CCW.
2	IF coil	Output 55dB Genescope	Same as above		T09	Max. IF waveform 2 Fig. 3-7	
3	IF coil	Output 45dB Genescope	Same as above		T10	Max. IF waveform 3 Fig. 3-8	○ If not, readjust T08 & T09 slightly
4	535kHz Dial calibration	535kHz ANT input 60dB 400Hz (30% MOD) AM SSG Use loop ANT	Bar ANT	REC OUT L or R-ch VTVM & Scope	T11	Max. output	○ If broadcasting station is near, it might be used 
5	1400kHz Dial Calibration	1400kHz ANT input 60dB 400Hz (30% MOD) AM SSG Use loop ANT	Same as above	Same as above	Trimmer Cap. TC06	Same as above	Same as above 
6	Confirm 600Hz Dial Calibration	600kHz ANT input 60dB 400Hz (30% MOD) AM SSG Use loop ANT	Same as above	Same as above		Confirm 600kHz Dial Calibration	○ If not, repeat from Step 4
7	Confirm 1000Hz Dial Calibration	1000kHz ANT input 60dB 400Hz (30% MOD) AM SSG Use loop ANT	Same as above	Same as above		Confirm 1000kHz Dial Calibration	
8	Confirm 1400kHz Dial Calibration	Same as Step 5	Same as above	Same as above		Confirm 1400kHz Dial Calibration	○ If not, repeat from Step 5
9	600kHz RF Adj.	600kHz ANT input 50dB 400Hz (30% MOD) AM SSG Use loop ANT	Same as above	Same as above	Bar ANT L702	Max. output	
10	1400kHz RF Adj.	1400kHz ANT input 50dB 400Hz (30% MOD) AM SSG Use loop ANT	Same as above	Same as above	Trimmer Cap. TC05	Same as above	
11	Signal Meter	1000kHz ANT input 100dB 400Hz (30% MOD) AM SSG Use loop ANT	Same as above	Same as above	F-1479 VR06	4 on meter 	○ Tune AM SSG (Max. indication of signal meter) ○ Before adjustment, if meter swang out or not enough, preadjust VR06 until the reasonable point

Fig. 3-6

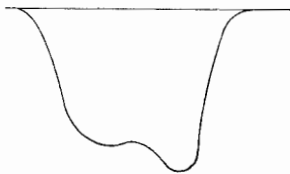


Fig. 3-7

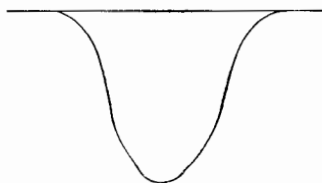


Fig. 3-8

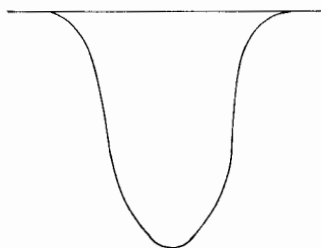


Fig. 3-9

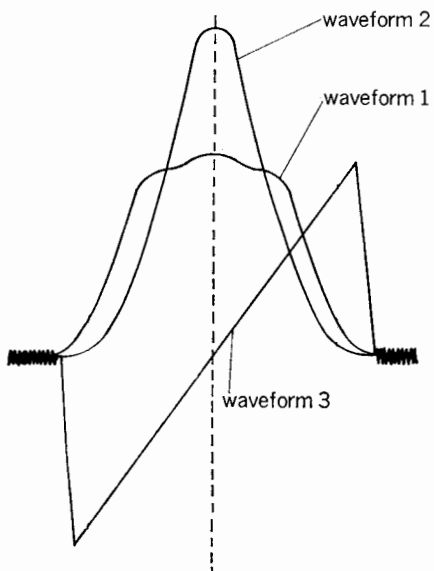
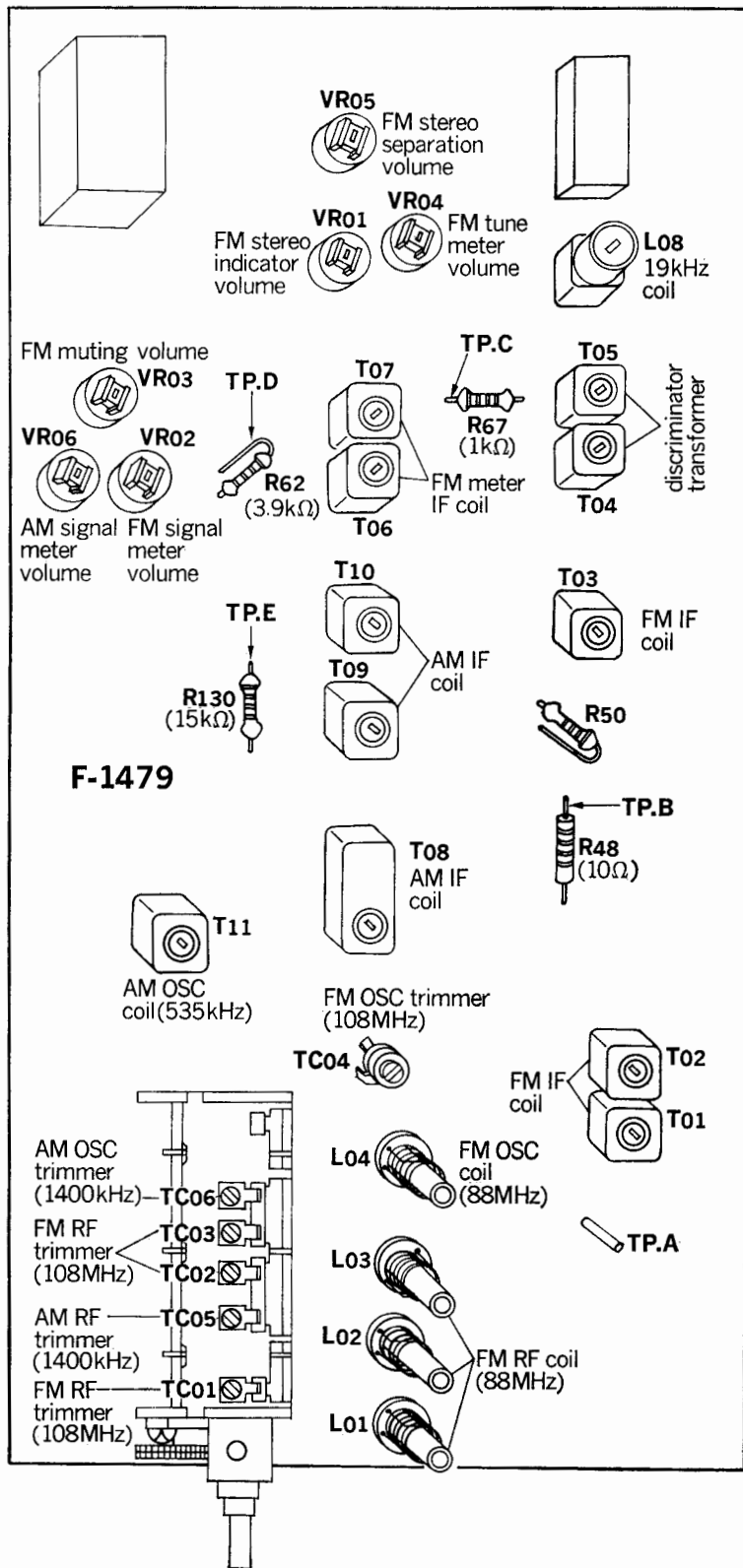


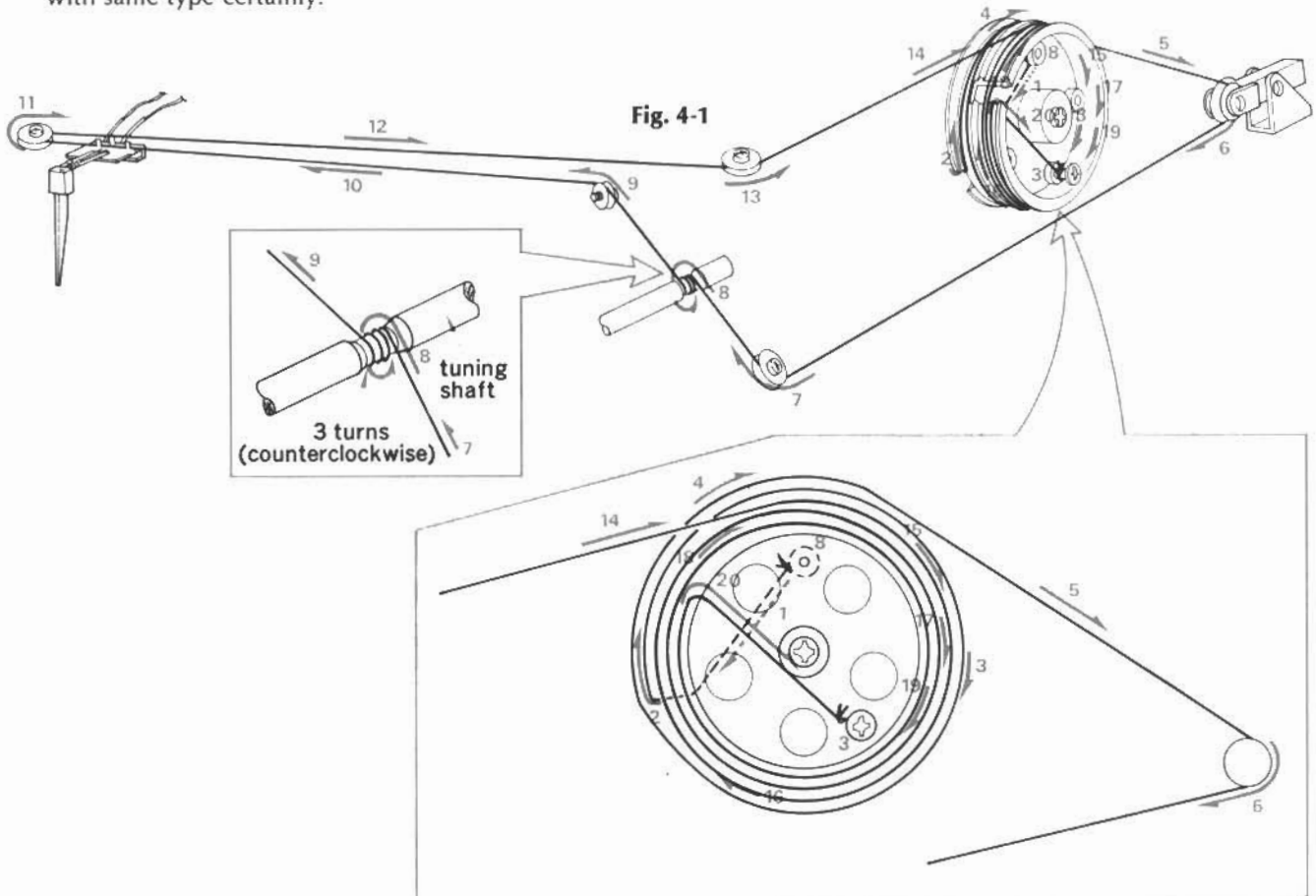
Fig. 3-10



4. THREADING OF DIAL CORD

* If dial cord is or slips, replace cord by following procedures. As QRX-5500 is using 0.6mmφ cord, please use with same type certainly.

* Length of dial cord approx. 210cm (82.7 inch)



1. How to Thread Dial Cord

* Thread dial cord in numerical order from 1 to 20 as shown in Fig. 4-1.

- 1) Close the variable capacitor completely (Maximum capacitance).
- 2) Tie cord to number ⑧ screw of the dial pulley and thread cord in direction of arrow from 1 to 7 toward tuning shaft 8.
- 3) After 8, wind cord three turns around the tuning shaft counterclockwise and thread it in direction of arrow from 9 to 19.
- 4) After 20, tie cord to number ③ screw of the pulley.

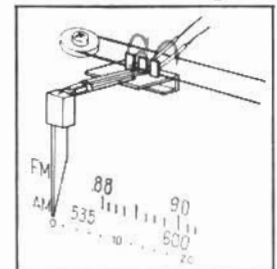
* In order to proceed with the above procedure 4) successfully, please follow the instruction under-mentioned.

- (1) To strengthen the dial cord's tension, hold around the end of cord and pull it toward the Front Panel.
- (2) Then, turn the tuning shaft counterclockwise, as cord's tension will be more constantly obtained.
- (3) Tie the cord to number ③ screw of the pulley (same as procedure 4).

- 5) After these procedures, lock the knots of cord with paint.

2. Attachment of Dial Pointer

- 1) Close the variable capacitor completely (Maximum capacitance).
- 2) Set the dial pointer to "0" on dial scale and tighten the dial pointer ass'y. (See Fig. 4-2)



* Make sure that the dial mechanism operates smoothly by turning the Tuning knob.

Stock No.	Description
6036050	Dial Cord 0.6mmφ

5. TROUBLESHOOTING CHART

5-1. Troubleshooting on Power Supply Section

1. No power supplied to each section

Symptom	Check Point	Cause & What to Do
1-1. Each lamp not lighted		1. Imperfect contact of power supply plug 2. Power fuse open 3. Defective power switch S705 4. F01 on F-1483 open 5. Defective power transformer PT001
1-2. Each lamp lighted		
1) +31V not supplied to terminal	05 on F-1482	6. Defective D07, D08 on F-1483
2) -31V not supplied to terminal	07 on F-1482	7. Defective D05, D06 on F-1483
3) +42V not supplied to terminal	6F on F-1472	8. F02, F03 on F-1483 open 9. Defective D02 on F-1483 10. Defective TR03, TR04 on F-1483
4) +25V not supplied to terminal	25 on F-2047	11. Defective TR05 on F-1483 12. Imperfect contact of VR01 on F-1483 13. Defective D15 on F-1483

5-2. Troubleshooting on Audio Section

1. Quick acting fuse open

1-1. After replacement, fuse not open	1. Set the bias current to 25mA
1-2. After replacement, fuse open again	2. Defective TR37, TR41 (TR38, TR42) on F-1482 3. Defective TR29, TR33 (TR30, TR34) on F-1482 4. Defective TR25 (TR26) on F-1482

2. 2-CH of FUNCTION inoperative

2-1. Both channels inoperative	5. Defective power supply section (See 5-1)
2-2. One channel inoperative	6. Imperfect contact of TAPE MONITOR switch S01 (S02) on F-1489 7. Defective TR01, TR03, TR05, TR07 (TR02, TR04, TR06, TR08) on F-1484 8. Imperfect contact of Low Filter switch S01 (S02) on F-1486 9. Imperfect contact of High Filter switch S03 (S04) on F-1486 10. Imperfect contact of Direction switch S703a~d 11. Defective F-1482 printed board

3. PHONO inoperative

Symptom	Check Point	Cause & What to Do
3-1. Both channels inoperative		12. Defective power supply section (See 5-1)
3-2. One channel inoperative		
1. Reverse the output cords of L and R-ch from turntable		
1-1. Inoperative channel reverses		13. Imperfect contact of turntable output cord 14. Defective turntable
1-2. Inoperative channel not reverses		15. Defective TR601, TR603, TR605, TR607 (TR602, TR604, TR606, TR608) on F-1472 16. Imperfect contact of SELECTOR switch S701a (S701b)

4. MIC inoperative

4-1. Both channels inoperative		
1. +42V not supplied to terminal 43 on F-1489		17. Defective power supply section (F-1483)
2. -42V supplied to terminal 43 on F-1489		18. Defective TR01, TR02 on F-1489 19. Defective VR707
4-2. One channel inoperative		20. Defective FET01 (FET02) on F-1489 21. Defective TR03 (TR04) on F-1489 22. Imperfect contact of Microphone Jack (J701) 23. Defective VR705 (VR706)

5. Level Meter inoperative

5-1. 4-channels inoperative		24. Defective power supply section (See 5-1) 25. Defective F-2048, F-2047
5-2. Two channels inoperative		
1) Front two channels inoperative		26. Defective TR01, TR05 (TR02, TR06) on F-1485 27. Defective D01, D05, D09, D13, (D02, D06, D10, D14) on F-1485 28. Defective VR01 (VR02) on F-1485 29. Defective Meter
2) Rear two channels inoperative		30. Defective TR03, TR07 (TR04, TR08) on F-1485 31. Defective D03, D07, D11, D15 (D04, D08, D12, D16) on F-1485 32. Defective Meter 33. Defective F-2048, F-2047

6. QS SYNTHESIZER or QS REGULAR MATRIX of FUNCTION Switch inoperative

Symptom	Check Point	Cause & What to Do
*QS Regular Matrix circuit consists of both F-2047 and F-2048 printed boards. (2-CH of FUNCTION switch operative)		
6-1. Both Front and Rear inoperative	—————	34. Defective power supply section (See 5-1)
6-2. One Front and Rear inoperative	—————	35. Defective TR01, TR04 (TR02, TR05) on F-2048
		36. Defective TR01, TR03, TR05 (TR02, TR04, TR06) on F-2047
		37. Defective D09, D11, D13, D15 (D10, D12, D14, D16) on F-2047
		38. Defective FET01 (FET02) on F-2047
		39. Defective TR07 (TR08, TR09) on F-2047
		40. Defective TR05, TR09, TR13 (TR06, TR10, TR14) on F-2048
		41. Defective TR07, TR11, TR15 (TR08, TR12, TR16) on F-2048
		42. Defective FUNCTION switch S702a~f

5-3. Troubleshooting on RF Section

1. Both FM and AM inoperative (PHONO operative)

1-1. Both channels inoperative		
1) +13V not supplied to terminal 03, 06, 16 on F-1479	—————	1. Defective power supply section (F-1483)
2) +13V not supplied to terminal 03, 06, on F-1479	—————	2. Imperfect contact of SELECTOR switch S701I
1-2. One channel inoperative		
1) AM section inoperative	—————	3. Defective SELECTOR switch S701a (701b)
2) FM section inoperative	—————	4. Defective SELECTOR switch S701a (701b)
		5. Defective TR17 (TR18) on F-1479
		6. Defective Low Pass Filter L.P. F01

2. FM Section

Symptom	Check Point	Cause & What to Do
*Before check, set MUTING switch to OFF (Pushed in)		
2-1. FM inoperative only		
1. Tune FM signal or FM broadcasting station		
1-1. Signal meter inoperative		<ul style="list-style-type: none"> 7. Defective IC01, IC02 on F-1479 8. Defective T01~T05 on F-1479 9. Defective D01, D02 on F-1479 10. Defective IC03 on F-1479
1-2. Signal meter operative (Interstation noise too low compared with proper unit)		<ul style="list-style-type: none"> 11. Defective CF01~CF03 on F-1479 12. Defective FET01, TR01, TR02 on F-1479 13. Defective TR05~TR10 on F-1479 14. Defective L01~L03 on F-1479 15. Defective T01~T05 on F-1479
2-2. Signal meter inoperative (FM broadcasting sound can be heard)		<ul style="list-style-type: none"> 16. IF, RF out of adjustment on F-1479 17. Defective TR11, TR12 on F-1479 18. Defective T06, T07 on F-1479 19. Defective D03, D04 on F-1479 20. Defective VR02 on F-1479 21. Defective signal meter
2-3. Tune meter inoperative (FM broadcasting sound can be heard)		<ul style="list-style-type: none"> 22. T04, T05, out of adjustment on F-1479 23. IF out of adjustment on F-1479 24. Discriminator coil out of adjustment on F-1479 25. Defective Tune meter
2-4. Muting circuit inoperative (Signal meter operative)		<ul style="list-style-type: none"> 26. Defective TR13~TR15 on F-1479 27. Defective TR19, TR20 on F-1479 28. Defective D05 on F-1479 29. Defective VR03 on F-1479 30. Imperfect contact of MUTING switch S41

Symptom	Check Point	Cause & What to Do
2-5. No channel separation on FM stereo broadcasting	*Confirm that SELECTOR switch is set to FM AUTO. *Confirm signal meter operates	
1. Indicator lamp not lighted		<ul style="list-style-type: none"> —31. Defective the indicator lamp PL726 —32. Defective TR16 on F-1479 —33. Defective L08 on F-1479 —34. Defective IC03 on F-1479 —35. Defective VR01 for indicator lamp on F-1479 —36. Defective VR05 for FM stereo separation on F-1479 —37. Defective F-1483
2. Indicator lamp lighted		<ul style="list-style-type: none"> —38. Defective TR16 on F-1479

3. AM Section

3-1. AM inoperative

1. Interstation noise changes by touching the terminal 04 on F-1479

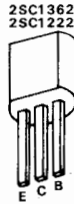
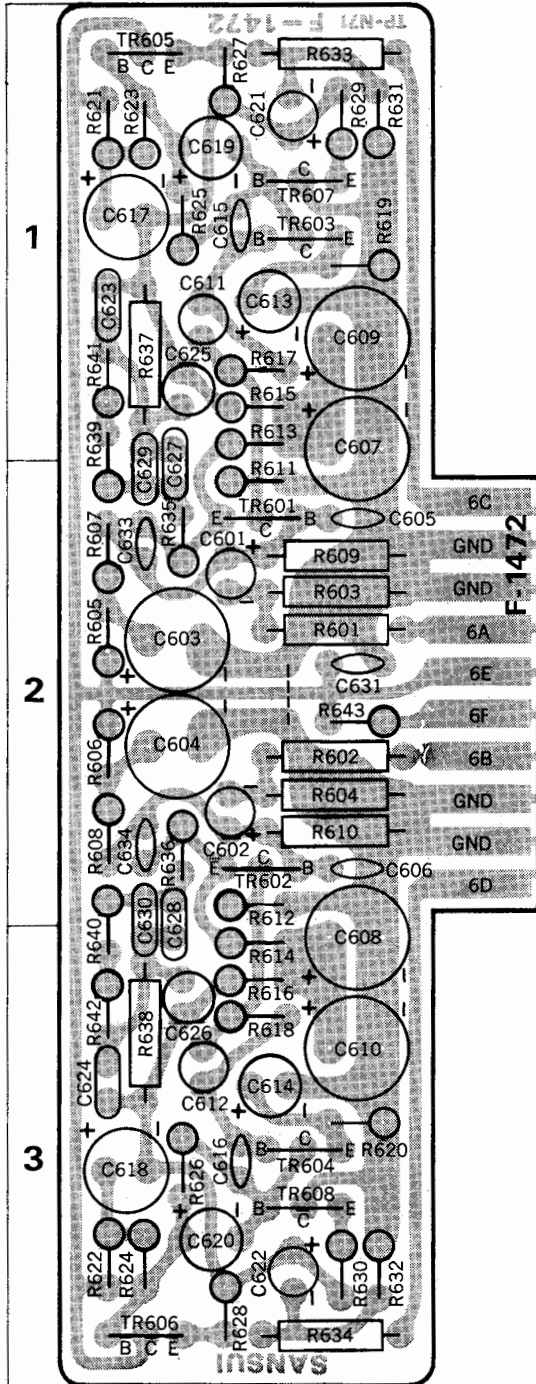
1-1. Increase		<ul style="list-style-type: none"> —39. Defective bar antenna —40. Defective TR24 on F-1479 —41. Defective T11 on F-1479 —42. Variable capacitor shorted
1-2. No change		<ul style="list-style-type: none"> —43. Defective D07 on F-1479 —44. Defective TR21~TR23 on F-1479 —45. Defective T08~T10 on F-1479
3-2. Distortion		<ul style="list-style-type: none"> —46. Defective D06, D07 on F-1479 —47. IF out of adjustment on F-1479
3-3. Signal meter inoperative (AM broadcasting sound can be heard)		<ul style="list-style-type: none"> —48. IF, RF out of adjustment on F-1479 —49. Defective TR25 on F-1479 —50. Defective D08, D09 on F-1479 —51. Imperfect contact of VR06 on F-1479 —52. Defective signal meter

6. PARTS LOCATIONS AND PARTS LIST

6-1. F-1472A Equalizer Circuit Board

(Stock No. 7550510 Complete Circuit Board F-1472A)

Conductor Side



Parts List

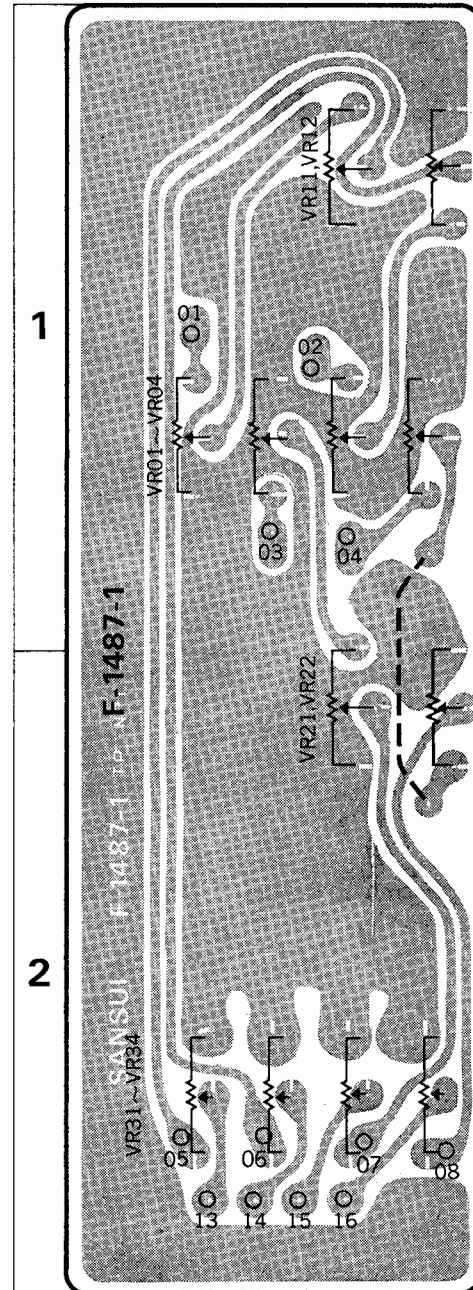
Parts No.	Stock No.	Description	Position	
TR601	0300410, 1	2SA726 [®] (F, G)	2	
TR602	0300410, 1	2SA726 [®] (F, G)		
TR603	0305766, 7	2SA632A [®] (71, 81)	1	
		or		
		or		
		or		
TR604	0306011, 2	2SC1222 (F, E)	3	
		or		
		or		
		or		
TR605	0306071, 2	2SC1313 [®] (G, H)	1	
		or		
TR606	0306141, 2	2SC1362 (71, 81)	3	
		or		
TR607	0300292, 3	2SA678 (7, 8)	1	
TR608	0300292, 3	2SA678 (7, 8)	3	
C601	0573229	2.2 μ F	25V T.C.	2
C602	0573229	2.2 μ F	25V T.C.	2
C603	0515330	33 μ F	50V E.C.	2
C604	0515330	33 μ F	50V E.C.	2
C605	0660330	33 pF	50V C.C.	2
C606	0660330	33 pF	50V C.C.	2
C607	0513470	47 μ F		1, 2
C608	0513470	47 μ F	25V E.C.	2, 3
C609	0513470	47 μ F	25V E.C.	1
C610	0513470	47 μ F		3
C611	0620681	680 pF	$\pm 5\%$ 50V P.C.	1
C612	0620681	680 pF	$\pm 5\%$ 50V P.C.	3
C613	0511330	33 μ F	10V E.C.	1
C614	0511330	33 μ F	10V E.C.	3
C615	0660220	22 pF	$\pm 10\%$ 50V C.C.	1
C616	0660220	22 pF	$\pm 10\%$ 50V C.C.	3
C617	0515100	10 μ F	50V E.C.	1
C618	0515100	10 μ F	50V E.C.	3
C619	0511330	33 μ F	10V E.C.	1
C620	0511330	33 μ F	10V E.C.	3
C621	0519101	1 μ F	50V E.C.	1
C622	0519101	1 μ F	50V E.C.	3
C623	0600226	0.0022 μ F	$\pm 5\%$ 50V M.C.	1
C624	0600226	0.0022 μ F	$\pm 5\%$ 50V M.C.	3
C625	0620821	820 pF	$\pm 5\%$ 50V P.C.	1
C626	0620821	820 pF	$\pm 5\%$ 50V P.C.	3
C631	0657223	0.022 μ F	50V C.C.	2
R601	0107222	2.2k Ω	$\pm 5\%$ 1/4W C.R.	2
R602	0107222	2.2k Ω		
R603	0107683	68k Ω	$\pm 5\%$ 1/4W C.R.	2
R604	0107683	68k Ω		
R605	0106184	180k Ω	$\pm 5\%$ 1/4W C.R.	2
R606	0106184	180k Ω		
R607	0106334	330k Ω	$\pm 5\%$ 1/4W C.R.	2
R608	0106334	330k Ω		
R609	0107394	390k Ω	$\pm 5\%$ 1/4W C.R.	2
R610	0107394	390k Ω		
R611	0106223	22k Ω	$\pm 5\%$ 1/4W C.R.	2
R612	0106223	22k Ω		
R613	0106821	820 Ω	$\pm 5\%$ 1/4W C.R.	1

6-2. F-1487 Volume Circuit Board

(Stock No. 7591850 Complete Circuit Board F-1487)

Conductor Side

Parts No.	Stock No.	Description	Position
R614	0106821	820Ω	3
R615	0106563	56kΩ	1
R616	0106563	56kΩ	3
R617	0106224	220kΩ	1
R618	0106224	220kΩ	3
R619	0106222	2.2kΩ	1
R620	0106222	2.2kΩ	3
R621	0106103	10kΩ	1
R622	0106103	10kΩ	3
R623	0106473	47kΩ	± 5% ¼W C.R. (E.L.R.)
R624	0106473	47kΩ	
R625	0106332	3.3kΩ	1
R626	0106332	3.3kΩ	3
R627	0106680	68Ω	1
R628	0106680	68Ω	3
R629	0106680	68Ω	1
R630	0106680	68Ω	3
R631	0106104	100kΩ	1
R632	0106104	100kΩ	3
R633	0107681	680Ω	± 5% ¼W C.R.
R634	0107681	680Ω	
R635	0106101	100Ω	± 5% ¼W C.R. (E.L.R.)
R636	0106101	100Ω	
R637	0107273	27kΩ	± 5% ¼W C.R.
R638	0107273	27kΩ	
R639	0106274	270kΩ	1, 2
R640	0106274	270kΩ	
R641	0106223	22kΩ	± 5% ¼W C.R. (E.L.R.)
R642	0106223	22kΩ	
R643	0106101	100Ω	2



Abbreviations

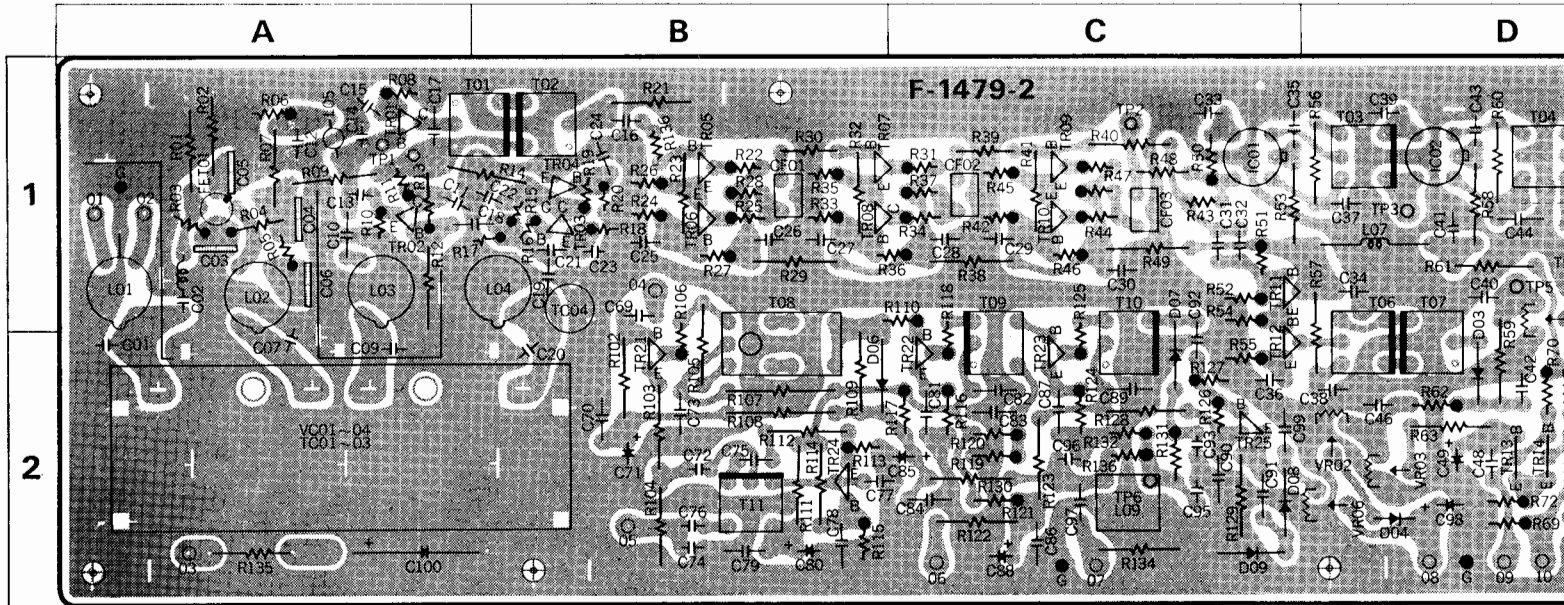
C.R. : Carbon Resistor	BP.E.C. : Bi-Pola Electrolytic Capacitor
S.R. : Solid Resistor	C.C. : Ceramic Capacitor
Ce.R. : Cement Resistor	Mi.C. : Mica Capacitor
M.R. : Metallized Film Resistor	O.C. : Oil Capacitor
M.C. : Mylar Capacitor	P.C. : Polystyrene Capacitor
E.C. : Electrolytic Capacitor	T.C. : Tantalum Capacitor

Parts List

Parts No.	Stock No.	Description	Position
VR01-04	1060250, 1	250kΩ (HB) × 4	Variable Resistor
VR11, 12	1010400, 1	250kΩ (HB)	
VR21, 22	1010400, 1	250kΩ (HB)	
VR31-34	1060240, 1	250kΩ (B) × 4	2

6-3. F-1479A Tuner Circuit Board (Stock No. 7520700 Complete Circuit Board F-1479A)

Conductor Side

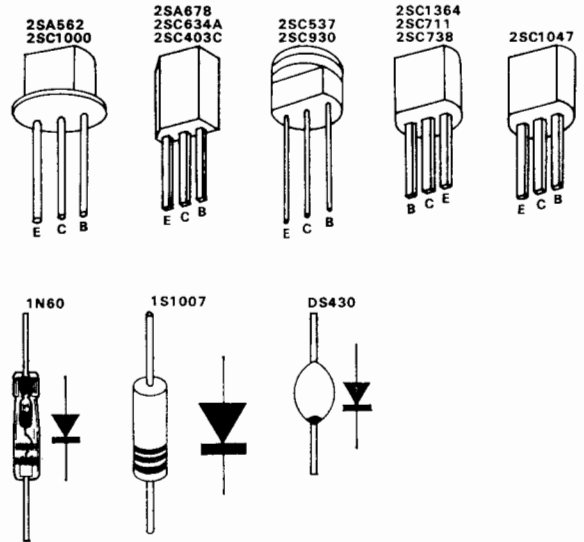
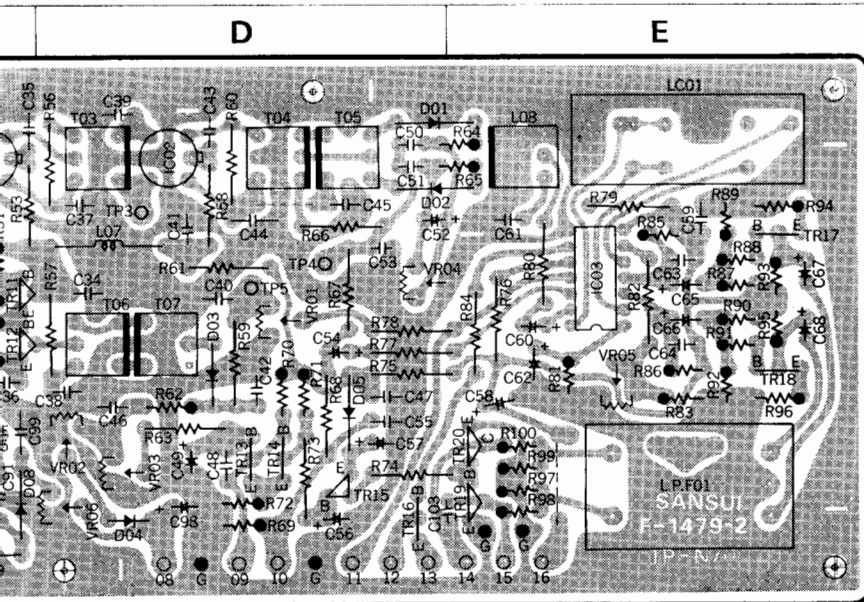


Parts List

Parts No.	Stock No.	Description	Position
TR01	0305801	2SC1047 (B)	1 A
TR02	0305802	2SC1047 (C)	1 A
TR03	0305790, 1	2SC930 (C,D)	1 B
TR04	0305440	2SC537 (E)	1 B
TR05	0306113	2SC738 (D)	1 B
TR06	0306113	2SC738 (D)	1 B
TR07	0306113	2SC738 (D)	1 B, C
TR08	0306113	2SC738 (D)	1 B, C
TR09	0306113	2SC738 (D)	1 C
TR10	0306113	2SC738 (D)	1 C
TR11	0305791	2SC930 (D)	1 C
TR12	0305791	2SC930 (D)	1, 2 C
TR13	0305733	2SC711 (G)	2 D
TR14	0305733	2SC711 (G)	2 D
TR15	0300291, 2	2SA678 (6, 7)	2 D
TR16	0300221	2SA562 (Y)	2 D
TR17	0306132	2SC1364 (7)	1 E
TR18	0306132	2SC1364 (7)	2 E
TR19	0305891	2SC634A (6)	2 E
TR20	0305891	2SC634A (6)	2 E
TR21	0305992	2SC403C (4)	2 B
TR22	0305992	2SC403C (4)	2 C
TR23	0305992	2SC403C (4)	2 C
TR24	0305991	2SC403C (3)	2 B
TR25	0305991	2SC403C (3)	2 C
IC01	0360070	μpc555A	1 C
IC02	0360070	μpc555A	1 D
IC03	0360080	HA1120	1 E
FET01	0370132	3SK41 (K)	FET 1 A
D01	0311016	1N60	1 D, E
D02	0311016	1N60	1 D, E
D03	0310331	1N60	2 D
D04	0340090	DS430	2 D

Parts No.	Stock No.	Description	Position
D05	0340090	DS430	2 D
D06	0310331	1N60	2 B
D07	0311090	1S1007-J	Diode 1, 2 C
D08	0310331	1N60	2 C
D09	0310331	1N60	2 C
T01	4235890	10.7MHz (WHITE)	1 A, B
T02	4235900	10.7MHz (BLACK)	FM IFT 1 B
T03	4235860	10.7MHz (BLACK)	1 D
T04	4235750	10.7MHz (PINK)	FM Discriminator Coil 1 D
T05	4235760	10.7MHz (BLUE)	1 D
T06	4235840	10.7MHz (BLUE)	FM IFT 1, 2 D
T07	4235920	10.7MHz (BLACK)	FM IFT 1, 2 D
T08	0910180	YEL-455E2 (CFW-455B)	Ceramic Filter 1, 2 B
T09	4230610	455kHz (BLACK)	AM IFT 1, 2 C
T10	4230580	455kHz (BLUE)	AM IFT 1, 2 C
T11	4220380	AM OSC Coil	2 B
CF01	0910150	SFE-10.7MA-M	Ceramic Filter 1 B
CF02	0910150	SFE-10.7MA-M	1 C
CF03	0910150	SFE-10.7MA-M	1 C
L01	4200560	FM ANT Coil	1 A
L02	4210300	FM RF Coil	1, 2 A
L03	4210300	FM RF Coil	1 A
L04	4220530	OSC Coil	1 A, B
L05	4290110	Choke Coil	1 A
L07	4290011	3.5μH Choke Coil	1 D
L08	4240720	19kHz Coil	1 E
L09	4290030	Peaking Coil	2 C
LC01	4240710	MPX Coil	1 E
LPF01	0910210	Low Pass Filter	2 E
VC01~04	1220130	Variable Capacitor	2 A, B
C01	0669368	6.8pF ±0.25pF 50V C.C.	2 A

Parts No.
C02
C03
C04
C05
C06
C07
C08
C09
C10
C11
C12
C13
C14
C15
C16
C17
C18
C19
C20
C21
C22
C23
C24
C25
C26
C27
C28
C29
C30
C31
C32
C33
C34
C35
C36
C37
C38



Position	Parts No.	Stock No.	Description	Position
	C02	0656102	0.001 μ F 50V C.C.	1 A
	C03	0659015	2200pF 50V C.C.	1 A
	C04	0659015	2200pF 50V C.C.	1 A
	C05	0659015	2200pF 50V C.C.	1 A
	C06	0659015	2200pF 50V C.C.	1 A
	C07	0669370	10pF \pm 5pF 50V C.C.	1, 2 A
	C08	0679023	0.39pF \pm 5% 50V C.C.	
	C09	0669370	10pF \pm 5pF 50V C.C.	2 A
	C10	0669209	8.2pF \pm 0.25pF 50V C.C.	1 A
	C11	0656223	0.022 μ F 50V C.C.	1 A
	C12	0660221	220pF \pm 10% 50V C.C.	1 A
	C13	0669221	22pF \pm 5% 50V C.C.	1 A
	C14	0669209	8.2pF \pm 0.25pF 50V C.C.	1 A
	C15	0656223	0.022 μ F 50V C.C.	1 A
	C16	0656223	0.022 μ F \pm 5% 50V C.C.	1 B
	C17	0656223	0.022 μ F 50V C.C.	1 A
	C18	0669204	3.3pF \pm 0.25pF 50V C.C.	1 A, B
	C19	0669370	10pF \pm 5pF 50V C.C.	1 B
	C20	0669215	15pF \pm 5% 50V C.C.	2 B
	C21	0669369	8.2pF \pm 0.25pF 50V C.C.	1 B
	C22	0656223	0.022 μ F 50V C.C.	1 B
	C23	0669375	15pF \pm 5% 50V C.C.	1 B
	C24	0656223	0.022 μ F 50V C.C.	1 B
	C25	0656223	0.022 μ F 50V C.C.	1 B
	C26	0656223	0.022 μ F 50V C.C.	1 B
	C27	0656223	0.022 μ F 50V C.C.	1 B
	C28	0656223	0.022 μ F 50V C.C.	1 C
	C29	0656223	0.022 μ F 50V C.C.	1 C
	C30	0656223	0.022 μ F 50V C.C.	1 C
	C31	0669224	33pF 50V C.C.	1 C
	C32	0669218	18pF 50V C.C.	1 C
	C33	0656223	0.022 μ F 50V C.C.	1 C
	C34	0656223	0.022 μ F 50V C.C.	1 D
	C35	0656223	0.022 μ F 50V C.C.	1 C
	C36	0656223	0.022 μ F 50V C.C.	2 C
	C37	0656223	0.022 μ F 50V C.C.	1 D
	C38	0656223	0.022 μ F 50V C.C.	2 D

Parts No.	Stock No.	Description	Position
C39	0656223	0.022 μ F 50V C.C.	1 D
C40	0656223	0.022 μ F 50V C.C.	1 D
C41	0656223	0.022 μ F 50V C.C.	1 D
C42	0669226	47pF 50V C.C.	2 D
C43	0656223	0.022 μ F 50V C.C.	1 D
C44	0656473	0.047 μ F 50V C.C.	1 D
C46	0656223	0.022 μ F 50V C.C.	2 D
C47	0656223	0.022 μ F 50V C.C.	2 D
C48	0656223	0.022 μ F 50V C.C.	2 D
C49	0573687	0.068 μ F \pm 20% 25V T.C.	2 D
C60	0660101	100pF \pm 10% 50V C.C.	1 D
C51	0660101	100pF \pm 10% 50V C.C.	1 D
C52	0519108	10 μ F 25V E.C.	1 D
C53	0660101	100pF \pm 10% 50V C.C.	1 D
C54	0513479	4.7 μ F 25V E.C.	2 D
C55	0656223	0.022 μ F 50V C.C.	2 D
C56	0519104	1.5 μ F \pm 20% 50V E.C.	2 D
C57	0515339	3.3 μ F 50V E.C.	2 D
C58	0512221	220 μ F 16V E.C.	2 E
C59	0656223	0.022 μ F 50V C.C.	1 E
C60	0515339	3.3 μ F 50V E.C.	1 E
C61	0629001	6800pF \pm 5% 50V P.C.	1 E
C62	0512100	10 μ F 16V E.C.	2 E
C63	0600187	0.018 μ F \pm 5% 50V M.C.	1 E
C64	0600187	0.018 μ F \pm 5% 50V M.C.	2 E

—Abbreviations—

C.R. : Carbon Resistor	BP.E.C.: Bi-Pola Electrolytic Capacitor
S.R. : Solid Resistor	C.C. : Ceramic Capacitor
Ce.R. : Cement Resistor	Mi.C. : Mica Capacitor
M.R. : Metallized Film Resistor	O.C. : Oil Capacitor
M.C. : Mylar Capacitor	P.C. : Polystyrene Capacitor
E.C. : Electrolytic Capacitor	T.C. : Tantalum Capacitor

Parts No.	Stock No.	Description	Position
C65	0519105	2.2 μ F	1 E
C66	0519105	2.2 μ F	1 E
C67	0519105	2.2 μ F	1 E
C68	0519105	2.2 μ F	1, 2 E
C69	0656223	0.022 μ F	1 B
C70	0656223	0.022 μ F	2 B
C71	0519102	3.3 μ F $\pm 20\%$	50V E.C. 2 B
C72	0600107	0.01 μ F $\pm 5\%$	50V M.C. 2 B
C73	0656473	0.047 μ F	50V C.C. 2 B
C74	0669215	15pF	50V C.C. 2 B
C75	0600107	0.01 μ F $\pm 5\%$	50V M.C. 2 B
C76	0620361	360pF $\pm 5\%$	50V P.C. 2 B
C77	0669223	27pF $\pm 5\%$	50V C.C. 2 B, C
C78	0656473	0.047 μ F	50V C.C. 2 B
C79	0656473	0.047 μ F	50V C.C. 2 B
C80	0512470	47 μ F	16V E.C. 2 B
C81	0656473	0.047 μ F	2 C
C82	0656473	0.047 μ F	50V C.C. 2 C
C83	0656473	0.047 μ F	50V C.C. 2 C
C84	0656473	0.047 μ F	2 C
C85	0512100	10 μ F	16V E.C. 2 C
C86	0656473	0.047 μ F	50V C.C. 2 C
C87	0601108	0.1 μ F $\pm 10\%$	50V M.C. 2 C
C88	0512470	47 μ F	16V E.C. 2 C
C89	0656473	0.047 μ F	2 C
C90	0656473	0.047 μ F	50V C.C. 2 C
C91	0656473	0.047 μ F	2 C
C92	0669226	47pF $\pm 5\%$	50V C.C. 1, 2 C
C93	0600476	0.047 μ F	$\pm 5\%$ 50V M.C. 2 C
C95	0600476	0.047 μ F	$\pm 5\%$ 50V M.C. 2 C
C96	0600107	0.01 μ F $\pm 5\%$	50V M.C. 2 C
C97	0601477	0.047 μ F $\pm 10\%$	50V M.C. 2 C
C98	0510101	100 μ F	6.3V E.C. 2 D
C99	0656473	0.047 μ F	50V C.C. 2 C
C100	0502100	10 μ F	16V E.C. 2 A, B
C103	0620221	220pF $\pm 5\%$	50V P.C. 2 D, E
C104	0669381	22pF $\pm 5\%$	50V C.C.
R01	0107104	100k Ω	$\pm 5\%$ 1/4 W C.R. 1 A
R02	0107181	180 Ω	1 A
R03	0106104	100k Ω	1 A
R04	0106224	220k Ω	$\pm 5\%$ 1/4 W 1 A
R05	0106220	22 Ω	C.R.(E.L.R.) 1 A
R06	0106562	5.6k Ω	1 A
R07	0107123	12k Ω $\pm 5\%$	1/4 W C.R. 1 A
R08	0106272	2.7k Ω $\pm 5\%$	1/4 W C.R. 1 A (E.L.R.)
R09	0107220	22 Ω $\pm 5\%$	1/4 W C.R. 1 A
R10	0106221	220 Ω	$\pm 5\%$ 1/4 W C.R. 1 A
R11	0106121	120 Ω	(E.L.R.) 1 A
R12	0107682	6.8k Ω $\pm 5\%$	1/4 W C.R. 1 A
R13	0106473	47k Ω $\pm 5\%$	1/4 W C.R. 1 A (E.L.R.)
R14	0107222	2.2k Ω $\pm 5\%$	1/4 W C.R. 1 A, B
R15	0106152	1.5k Ω	1 B
R16	0106270	27 Ω	1 B
R17	0106222	2.2k Ω	$\pm 5\%$ 1/4 W C.R. 1 B
R18	0107122	1.2k Ω	(E.L.R.) 1 B
R19	0106123	12k Ω	1 B
R20	0106332	3.3k Ω	1 B
R21	0107222	2.2k Ω $\pm 5\%$	1/4 W C.R. 1 B
R22	0106151	150 Ω $\pm 5\%$	1/4 W C.R. 1 B (E.L.R.)

Parts No.	Stock No.	Description	Position
R23	0107182	1.8k Ω $\pm 5\%$	1/4 W C.R. 1 B
R24	0106182	1.8k Ω	1 B
R25	0106151	150 Ω	1 B
R26	0106101	100 Ω	$\pm 5\%$ 1/4 W C.R. 1 B (E.L.R.)
R27	0106153	15k Ω	1 B
R28	0106331	330 Ω	1 B
R29	0107479	4.7 Ω $\pm 5\%$	1/4 W C.R. 1 B
R30	0113101	100 Ω $\pm 5\%$	1/4 W S.R. 1 B
R31	0106151	150 Ω $\pm 5\%$	1/4 W C.R. 1 C (E.L.R.)
R32	0107182	1.8k Ω $\pm 5\%$	1/4 W C.R. 1 B
R33	0106472	4.7k Ω	1 B
R34	0106151	150 Ω	1 C
R35	0106224	220k Ω	$\pm 5\%$ 1/4 W C.R. 1 B (E.L.R.)
R36	0106153	15k Ω	1 B, C
R37	0106471	470 Ω	1 C
R38	0107479	4.7 Ω $\pm 5\%$	1/4 W C.R. 1 C
R39	0113101	100 Ω $\pm 5\%$	1/4 W S.R. 1 C
R40	0106151	150 Ω $\pm 5\%$	1/4 W C.R. 1 C (E.L.R.)
R41	0107182	1.8k Ω $\pm 5\%$	1/4 W C.R. 1 C
R42	0106472	4.7k Ω $\pm 5\%$	1/4 W C.R. 1 C (E.L.R.)
R43	0107222	2.2k Ω $\pm 5\%$	1/4 W C.R. 1 C
R44	0106151	150 Ω	1 C
R45	0106224	220k Ω	$\pm 5\%$ 1/4 W 1 C
R46	0106153	15k Ω	C.R.(E.L.R.) 1 C
R47	0106471	470 Ω	1 C
R48	0113100	10 Ω $\pm 5\%$	1/4 W S.R. 1 C
R49	0107479	4.7 Ω $\pm 5\%$	1/4 W C.R. 1 C
R50	0106331	330 Ω	1 C
R51	0106473	47k Ω	$\pm 5\%$ 1/4 W C.R.(E.L.R.) 1 C
R52	0106153	15k Ω	1 C
R53	0107100	10 Ω $\pm 5\%$	1/4 W C.R. 1 C
R54	0106222	2.2k Ω	$\pm 5\%$ 1/4 W C.R. 1 C
R55	0106821	820 Ω	(E.L.R.) 2 C
R56	0107562	5.6k Ω	1 D
R57	0107101	100 Ω	1, 2 D
R58	0107100	10 Ω	$\pm 5\%$ 1/4 W C.R. 1 D
R59	0107103	10k Ω	1, 2 D
R60	0107682	6.8k Ω	1 D
R61	0107479	4.7 Ω	1 D
R62	0106392	3.9k Ω $\pm 5\%$	1/4 W C.R. 2 D (E.L.R.)
R63	0107683	68k Ω $\pm 5\%$	1/4 W C.R. 2 D
R64	0106102	1k Ω	$\pm 5\%$ 1/4 W C.R. 1 D, E (E.L.R.)
R65	0106102	1k Ω	1 D, E
R66	0107100	10 Ω	1 D
R67	0107102	1k Ω	$\pm 5\%$ 1/4 W C.R. 1, 2 D
R68	0107153	15k Ω	2 D
R69	0106152	1.5k Ω	2 D
R70	0106105	1M Ω	$\pm 5\%$ 1/4 W C.R. 2 D
R71	0106153	15k Ω	(E.L.R.) 2 D
R72	0106560	56 Ω	2 D
R73	0107473	47k Ω	2 D
R74	0107472	4.7k Ω	2 D, E
R75	0107479	4.7 Ω	2 D, E
R76	0107104	100k Ω	$\pm 5\%$ 1/4 W C.R. 1, 2 E
R77	0107100	10 Ω	2 D, E
R78	0107104	100k Ω	2 D, E
R79	0107221	220 Ω	1 E
R80	0107479	4.7 Ω	1 E
R81	0106472	4.7k Ω $\pm 5\%$	1/4 W C.R. 2 E (E.L.R.)

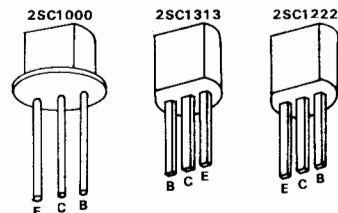
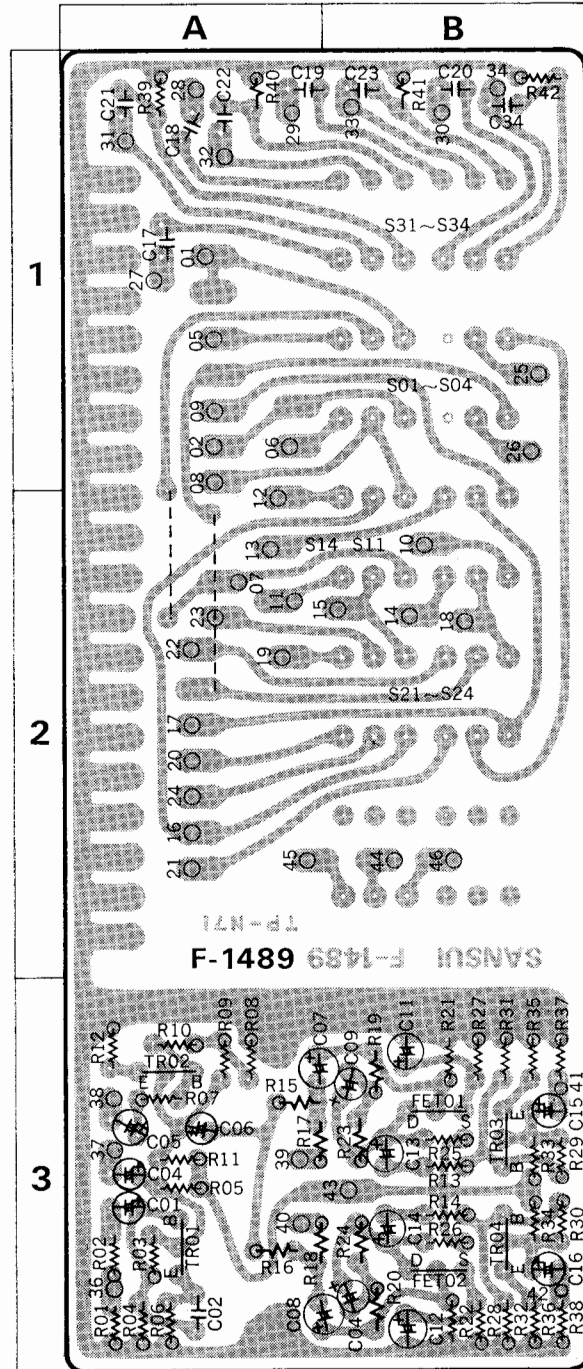
F-1479A Parts List

Parts No.	Stock No.	Description	Position
R82	0107151	150Ω ± 5% 1/4W C.R.	1, 2 E
R83	0106561	560Ω ± 5% 1/4W C.R. (E.L.R.)	2 E
R84	0107822	8.2kΩ ± 5% 1/4W C.R.	1, 2 E
R85	0106332	3.3kΩ	1 E
R86	0106332	3.3kΩ	2 E
R87	0106184	180kΩ	1 E
R88	0106332	3.3kΩ	1 E
R89	0106273	27kΩ	1 E
R90	0106184	180kΩ	1 E
R91	0106332	3.3kΩ	2 E
R92	0106273	27kΩ	2 E
R93	0106332	3.3kΩ ± 5% 1/4W C.R. (E.L.R.)	1 E
R94	0106391	390Ω	1 E
R95	0106332	3.3kΩ	1, 2 E
R96	0106391	390Ω	2 E
R97	0106332	3.3kΩ	2 E
R98	0106562	5.6kΩ	2 E
R99	0106332	3.3kΩ	2 E
R100	0106562	5.6kΩ	2 E
R102	0107103	10kΩ	2 B
R103	0107220	22Ω	2 B
R104	0107102	1kΩ ± 5% 1/4W C.R.	2 B
R105	0107224	220kΩ	1, 2 B
R106	0106561	560Ω ± 5% 1/4W C.R. (E.L.R.)	1, 2 B
R107	0107561	560Ω ± 5% 1/4W C.R. (E.L.R.)	2 B
R108	0107392	3.9kΩ ± 5% 1/4W C.R.	2 B
R109	0107123	12kΩ	2 B
R110	0106332	3.3kΩ ± 5% 1/4W C.R. (E.L.R.)	1 B, C
R111	0107272	2.7kΩ ± 5% 1/4W C.R.	2 B
R112	0107100	10Ω ± 5% 1/4W C.R.	2 B
R113	0106102	1kΩ ± 5% 1/4W C.R. (E.L.R.)	2 B
R114	0107223	22kΩ ± 5% 1/4W C.R.	2 B
R115	0106332	3.3kΩ	2 B
R116	0106102	1kΩ	2 C
R117	0106124	120kΩ ± 5% 1/4W C.R. (E.L.R.)	2 C
R118	0106681	680Ω ± 5% 1/4W C.R. (E.L.R.)	1, 2 C
R119	0106562	5.6kΩ	2 C
R120	0106822	8.2kΩ	2 C
R121	0106470	47Ω	2 C
R122	0107470	47Ω ± 5% 1/4W C.R.	2 C
R123	0107101	100Ω ± 5% 1/4W C.R. (E.L.R.)	2 C
R124	0106102	1kΩ	2 C
R125	0106471	470Ω ± 5% 1/4W C.R. (E.L.R.)	1, 2 C
R126	0106223	22kΩ	2 C
R127	0106103	10kΩ	2 C
R128	0107101	100Ω	2 C
R129	0107272	2.7kΩ ± 5% 1/4W C.R.	2 C
R130	0107153	15kΩ	2 C
R131	0106102	1kΩ ± 5% 1/4W C.R.	2 C
R132	0106472	4.7kΩ ± 5% 1/4W C.R. (E.L.R.)	2 C
R134	0107473	47kΩ ± 5% 1/4W C.R.	2 C
R136	0106332	3.3kΩ ± 5% 1/4W C.R. (E.L.R.)	1 B, 2 C
VR01	1035190	100kΩ(B)	1, 2 D
VR02	1035170	47kΩ(B)	2 D
VR03	1035190	100kΩ(B)	2 D
VR04	1035130	10kΩ(B)	1 D
VR05	1035070	1kΩ(B)	2 E
VR06	1035170	47kΩ(B)	2 D

6-4. F-1489 Mixing & Accessory Circuit Board

(Stock No. 7591870 Complete Circuit Board F-1489)

Conductor Side



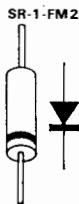
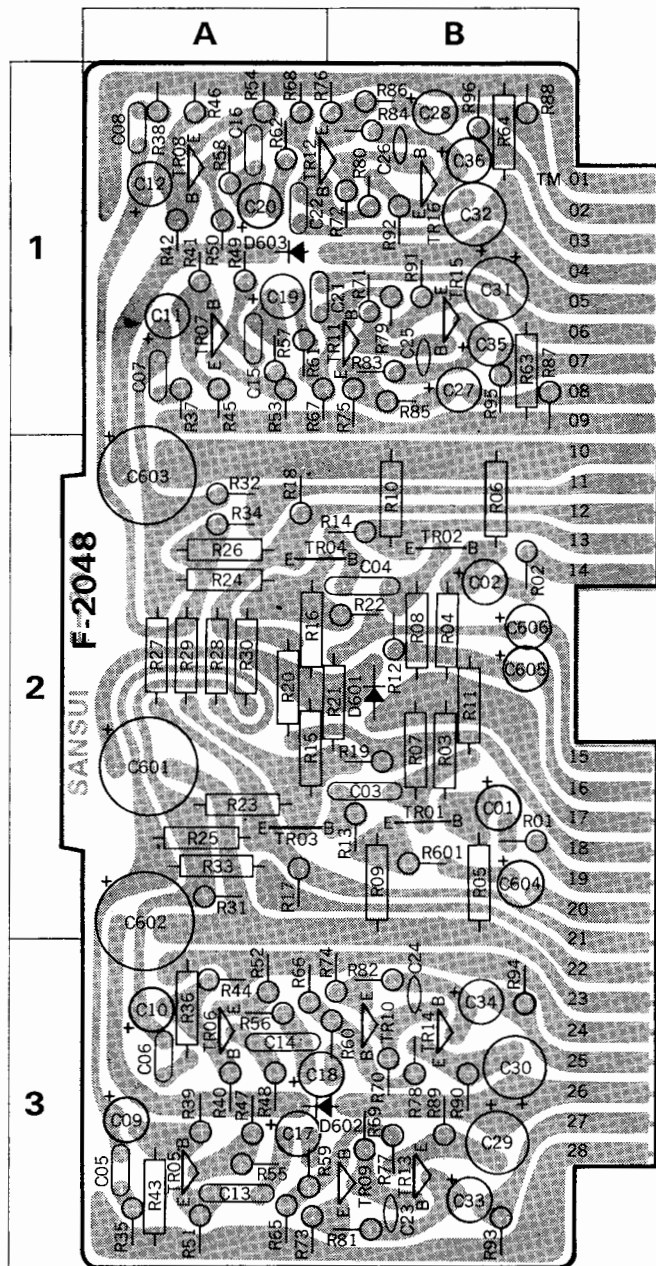
Parts List

Parts No.	Stock No.	Description	Position	Parts No.	Stock No.	Description	Position					
TR01	0306071, 2 or 0305880, 1	2SC1313 [Ⓡ] (G, H) or 2SC1000 (GR, BL)	3 A	R16	0106473	47kΩ	3 A					
				R17	0106473	47kΩ	3 A					
				R18	0106473	47kΩ	3 A					
TR02	0306011, 2 or 0306071, 2	2SC1222 (E, F) or 2SC1313 [Ⓡ] (G, H)	3 A	R19	0106563	56kΩ	3 B					
				R20	0106563	56kΩ	3 B					
				R21	0106683	68kΩ	3 B					
TR03	0305880, 1 or 0306011, 2	2SC1000 (GR, BL) or 2SC1222 (E, F)	3 B	R22	0106683	68kΩ	3 B					
				R23	0106334	330kΩ	3 B					
				R24	0106334	330kΩ	3 B					
TR04	0306071, 2 or 0305880, 1	2SC1313 [Ⓡ] (G, H) or 2SC1000 (GR, BL)	3 B	R25	0106562	5.6kΩ	3 B					
				R26	0106562	5.6kΩ	3 B					
				R27	0106681	680Ω	3 B					
FET01	0370061	2SK24 (F)	FET 3 B	R28	0106681	680Ω	3 B					
FET02	0370061	2SK24 (F)	FET 3 B	R29	0106274	270kΩ	3 B					
C01	0573108	0.1μF	25V T.C.	3 A	± 5% ¼W C.R. (E.L.R.)	R30	0106274	270kΩ	3 B			
C02	0660101	100pF	±10% 50V C.C.	3 A		R31	0106683	68kΩ	3 B			
C04	0573478	0.47μF	25V T.C.	3 A, 3 B		R32	0106683	68kΩ	3 B			
C05	0573478	0.47μF		3 A		R33	0106472	4.7kΩ	3 B			
C06	0573478	0.47μF	3 A	R34		0106472	4.7kΩ	3 B				
C07	0573688	0.68μF	3 A, B	C08		0573688	0.68μF	3 B	R35	0106102	1kΩ	3 B
C08	0573688	0.68μF		3 A, B		C09	0573478	0.47μF	3 B	R36	0106102	1kΩ
C09	0573478	0.47μF	3 B	C10		0573478	0.47μF	6.3V E.C.	R37	0106104	100kΩ	3 B
C10	0573478	0.47μF	3 B	C11		0510470	47μF		3 B	R38	0106104	100kΩ
C11	0510470	47μF	50V T.C.	C12		0510470	47μF	3 B	R39	0106333	33kΩ	1 A
C12	0510470	47μF		3 B		C13	0573339	3.3μF	3 B	R40	0106333	33kΩ
C13	0573339	3.3μF	50V P.C.	C14		0573339	3.3μF	3 B	R41	0106333	33kΩ	1 B
C14	0573339	3.3μF		3 B		C15	0519106	4.7μF	3 B	R42	0106333	33kΩ
C15	0519106	4.7μF	1 A	C16		0519106	4.7μF	3 B	1130750 Push Switch			
C16	0519106	4.7μF		3 B	C17	0620151	150pF	1 A				
C17	0620151	150pF	50V M.C.	C18	0620151	150pF	1 A					
C18	0620151	150pF		1 A	C19	0620151	150pF	1 A, B				
C19	0620151	150pF	50V C.C.	C20	0620151	150pF	1 B					
C20	0620151	150pF		1 B	C21	0600227	0.022μF	1 A				
C21	0600227	0.022μF	50V M.C.	C22	0600227	0.022μF	1 A					
C22	0600227	0.022μF		1 A	C23	0600227	0.022μF	1 B				
C23	0600227	0.022μF	50V C.C.	C24	0600227	0.022μF	1 B					
C24	0600227	0.022μF		1 B	C25	0657222	0.0022μF	50V C.C.				
C25	0657222	0.0022μF	50V C.C.	R01	0106103	10kΩ	3 A					
R01	0106103	10kΩ	± 5% ¼W C.R. (E.L.R.)	R02	0106102	1kΩ	3 A					
R02	0106102	1kΩ		3 A	R03	0106394	390kΩ	3 A				
R03	0106394	390kΩ		3 A	R04	0106563	56kΩ	3 A				
R04	0106563	56kΩ		3 A	R05	0106333	33kΩ	3 A				
R05	0106333	33kΩ		3 A	R06	0106272	2.7kΩ	3 A				
R06	0106272	2.7kΩ		3 A	R07	0106272	2.7kΩ	3 A				
R07	0106272	2.7kΩ		3 A	R08	0106394	390kΩ	3 A				
R08	0106394	390kΩ		3 A	R09	0106474	470kΩ	3 A				
R09	0106474	470kΩ		3 A	R10	0106274	270kΩ	3 A				
R10	0106274	270kΩ		3 A	R11	0106332	3.3kΩ	3 A				
R11	0106332	3.3kΩ		3 A	R12	0106152	1.5kΩ	3 A				
R12	0106152	1.5kΩ		3 A	R13	0106682	6.8kΩ	3 B				
R13	0106682	6.8kΩ		3 B	R14	0106682	6.8kΩ	3 B				
R14	0106682	6.8kΩ		3 B	R15	0106473	47kΩ	3 A				
R15	0106473	47kΩ	3 A					Abbreviations C.R. : Carbon Resistor BP.E.C.: Bi-Pola Electrolytic Capacitor S.R. : Solid Resistor Ce.R. : Cement Resistor C.C. : Ceramic Capacitor M.R. : Metallized Film Resistor Mi.C. : Mica Capacitor M.C. : Mylar Capacitor O.C. : Oil Capacitor E.C. : Electrolytic Capacitor P.C. : Polystyrene Capacitor T.C. : Tantalum Capacitor				

6-5. F-2048 Vario-Matrix Circuit Board

(Stock No. 7650120 Complete Circuit Board F-2048)

Conductor Side



Parts List

Parts No.	Stock No.	Description	Position
TR01	0305475	2SC871 (R) (F)	2 B
TR02	0305475	2SC871 (R) (F)	2 B
TR03	0305475	2SC871 (R) (F)	2 A, B
TR04	0305475	2SC871 (R) (F)	2 A, B
TR05	{ 0300470 or 0300410	{ 2SA726 (W) (F) or 2SA726 (R) (F)	3 A
TR06	0305475	2SC871 (R) (F)	3 A
TR07	0305475	2SC871 (R) (F)	1 A
TR08	{ 0300470 or 0300410	{ 2SA726 (W) (F) or 2SA726 (R) (F)	1 A
TR09	0305475	2SC871 (R) (F)	3 B
TR10	0305475	2SC871 (R) (F)	3 B
TR11	0305475	2SC871 (R) (F)	1 B
TR12	0305475	2SC871 (R) (F)	1 A, B
TR13	{ 0300470 or 0300410	{ 2SA726 (W) (F) or 2SA726 (R) (F)	3 B
TR14	{ 0300470 or 0300410	{ 2SA726 (W) (F) or 2SA726 (R) (F)	3 B
TR15	{ 0300470 or 0300410	{ 2SA726 (W) (F) or 2SA726 (R) (F)	1 B
TR16	{ 0300470 or 0300410	{ 2SA726 (W) (F) or 2SA726 (R) (F)	1 B
D601	{ 0310870 or 0310340	{ SR-1-FM2 or 10D-1	2 B
D602	{ 0300470 or 0300340	{ SR-1-FM2 or 10D-1	3 A, B
D603	{ 0310870 or 0310340	{ SR-1-FM2 or 10D-1	1 A
C01	0519102	3.3 μ F	50V E.C. 2 B
C02	0519102	3.3 μ F	2 B
C03	0600107	0.01 μ F	2 B
C04	0600107	0.01 μ F	2 B
C05	0600157	0.015 μ F	50V M.C. 3 A
C06	0600157	0.015 μ F	3 A
C07	0600107	0.01 μ F	1 A
C08	0600107	0.01 μ F	1 A
C09	0519105	2.2 μ F	50V E.C. 3 A
C10	0519105	2.2 μ F	3 A
C11	0573108	0.1 μ F	25V T.C. 1 A
C12	0573108	0.1 μ F	1 A
C13	0600607	0.06 μ F	3 A
C14	0600607	0.06 μ F	3 A
C15	0600126	0.0012 μ F	50V M.C. 1 A
C16	0600686	0.0068 μ F	1 A
C17	0573228	0.22 μ F	3 A
C18	0573228	0.22 μ F	25V T.C. 3 A, B
C19	0573228	0.22 μ F	1 A
C20	0573228	0.22 μ F	1 A
C21	0600106	0.001 μ F	50V M.C. 1 A
C22	0600156	0.0015 μ F	$\pm 5\%$ 50V M.C. 1 A
C23	0660470	47 pF	3 B
C24	0660470	47 pF	50V C.C. 3 B
C25	0660470	47 pF	1 B
C26	0660470	47 pF	1 B
C27	0513100	10 μ F	25V E.C. 1 B

Parts No.	Stock No.	Description	Position
C28	0513100	10 μ F	25V E.C. 1 B
C29	0510101	100 μ F	3 B
C30	0510101	100 μ F	6.3V E.C. 3 B
C31	0510101	100 μ F	1 B
C32	0510101	100 μ F	1 B
C33	0573478	0.47 μ F	3 B
C34	0573478	0.47 μ F	25V T.C. 3 B
C35	0573478	0.47 μ F	1 B
C36	0573478	0.47 μ F	1 B
C37	0666151	150 pF	
C38	0666151	150 pF	50V C.C.
C39	0666151	150 pF	
C40	0666151	150 pF	
C601	0513221	220 μ F	2 A
C602	0513221	220 μ F	25V E.C. 2, 3 A
C603	0513221	220 μ F	1, 2 A
C604	0513100	10 μ F	2 B
C605	0573108	0.1 μ F	25V T.C. 2 B
C606	0573108	0.1 μ F	2 B
R01	0106222	2.2k Ω	$\pm 5\%$ $\frac{1}{4}$ W C.R. 2 B
R02	0106222	2.2k Ω	(E.L.R.) 2 B
R03	0107224	220k Ω	2 B
R04	0107224	220k Ω	2 B
R05	0107104	100k Ω	2 B
R06	0107104	100k Ω	2 B
R07	0107222	2.2k Ω	$\pm 5\%$ $\frac{1}{4}$ W C.R. 2 B
R08	0107222	2.2k Ω	2 B
R09	0107222	2.2k Ω	2 B
R10	0107222	2.2k Ω	2 B
R11	0107224	220k Ω	2 B
R12	0106224	220k Ω	2 B
R13	0106223	22k Ω	$\pm 5\%$ $\frac{1}{4}$ W C.R. 2 B
R14	0106223	22k Ω	(E.L.R.) 2 B
R15	0107152	1.5k Ω	$\pm 5\%$ $\frac{1}{4}$ W C.R. 2 A
R16	0107152	1.5k Ω	2 A
R17	0106152	1.5k Ω	2 A
R18	0106152	1.5k Ω	$\pm 5\%$ $\frac{1}{4}$ W C.R. 2 A
R19	0106224	220k Ω	(E.L.R.) 2 B
R20	0107224	220k Ω	$\pm 5\%$ $\frac{1}{4}$ W C.R. 2 A
R21	0107224	220k Ω	2 B
R22	0106224	220k Ω	$\pm 5\%$ $\frac{1}{4}$ W C.R. 2 B
R23	0107104	100k Ω	(E.L.R.) 2 A
R24	0107104	100k Ω	2 A
R25	0107104	100k Ω	2 A
R26	0107104	100k Ω	$\pm 5\%$ $\frac{1}{4}$ W C.R. 2 A
R27	0107104	100k Ω	2 A
R28	0107104	100k Ω	2 A
R29	0107104	100k Ω	2 A
R30	0107104	100k Ω	2 A
R31	0106563	56k Ω	$\pm 5\%$ $\frac{1}{4}$ W C.R. 2 A
R32	0106563	56k Ω	(E.L.R.) 2 A
R33	0107563	56k Ω	$\pm 5\%$ $\frac{1}{4}$ W C.R. 2 A
R34	0106563	56k Ω	$\pm 5\%$ $\frac{1}{4}$ W C.R. 2 A
R35	0106563	56k Ω	(E.L.R.) 3 A
R36	0107563	56k Ω	$\pm 5\%$ $\frac{1}{4}$ W C.R. 3 A
R37	0106563	56k Ω	1 A
R38	0106563	56k Ω	1 A
R39	0106104	100k Ω	$\pm 5\%$ $\frac{1}{4}$ W C.R. 3 A
R40	0106224	220k Ω	(E.L.R.) 3 A
R41	0106224	220k Ω	1 A
R42	0106104	100k Ω	1 A

Parts No.	Stock No.	Description	Position
R43	0107224	220k Ω	$\pm 5\%$ $\frac{1}{4}$ W C.R. 3 A
R44	0106104	100k Ω	3 A
R45	0106104	100k Ω	1 A
R46	0106224	220k Ω	1 A
R47	0106682	6.8k Ω	3 A
R48	0106682	6.8k Ω	3 A
R49	0106682	6.8k Ω	1 A
R50	0106682	6.8k Ω	1 A
R51	0106682	6.8k Ω	3 A
R52	0106682	6.8k Ω	3 A
R53	0106682	6.8k Ω	$\pm 5\%$ $\frac{1}{4}$ W C.R. 1 A
R54	0106682	6.8k Ω	(E.L.R.) 1 A
R55	0106223	22k Ω	3 A
R56	0106223	22k Ω	3 A
R57	0106153	15k Ω	1 A
R58	0106153	15k Ω	1 A
R59	0106223	22k Ω	3 A
R60	0106223	22k Ω	3 B
R61	0106223	22k Ω	1 A
R62	0106223	22k Ω	1 A
R63	0107104	100k Ω	$\pm 5\%$ $\frac{1}{4}$ W C.R. 1 B
R64	0107104	100k Ω	1 B
R65	0106154	150k Ω	3 A
R66	0106154	150k Ω	3 A
R67	0106154	150k Ω	1 A, B
R68	0106154	150k Ω	1 A
R69	0106124	120k Ω	3 B
R70	0106124	120k Ω	3 B
R71	0106124	120k Ω	1 B
R72	0106124	120k Ω	1 B
R73	0106392	3.9k Ω	3 A
R74	0106392	3.9k Ω	3 B
R75	0106392	3.9k Ω	1 B
R76	0106392	3.9k Ω	1 A, B
R77	0106824	820k Ω	3 B
R78	0106824	820k Ω	3 B
R79	0106824	820k Ω	1 B
R80	0106824	820k Ω	$\pm 5\%$ $\frac{1}{4}$ W C.R. 1 B
R81	0106123	12k Ω	(E.L.R.) 3 B
R82	0106123	12k Ω	3 B
R83	0106123	12k Ω	1 B
R84	0106123	12k Ω	1 B
R85	0106123	12k Ω	1 B
R86	0106123	12k Ω	1 B
R87	0106104	100k Ω	1 B
R88	0106104	100k Ω	1 B
R89	0106122	1.2k Ω	3 B
R90	0106122	1.2k Ω	3 B
R91	0106122	1.2k Ω	1 B
R92	0106122	1.2k Ω	1 B
R93	0106104	100k Ω	3 B
R94	0106104	100k Ω	3 B
R95	0106104	100k Ω	1 B
R96	0106104	100k Ω	1 B

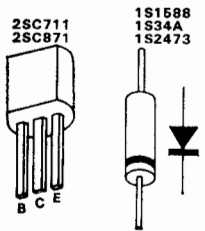
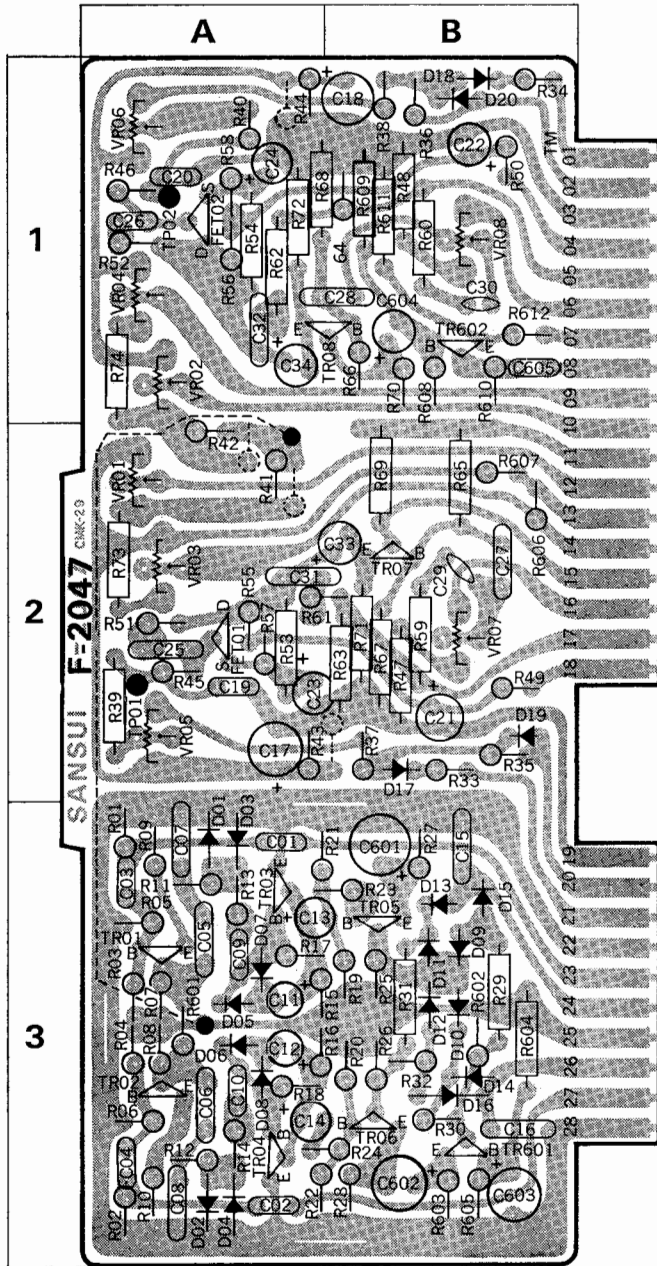
== Abbreviations ==

C.R. : Carbon Resistor	BP.E.C.: Bi-Pola Electrolytic Capacitor
S.R. : Solid Resistor	C.C. : Ceramic Capacitor
Ce.R. : Cement Resistor	Mi.C. : Mica Capacitor
M.R. : Metallized Film Resistor	O.C. : Oil Capacitor
M.C. : Mylar Capacitor	P.C. : Polystyrene Capacitor
E.C. : Electrolytic Capacitor	T.C. : Tantalum Capacitor

6-6. F-2047 Vario-Matrix Circuit Board

(Stock No. 7850110 Complete Circuit Board F-2047)

Conductor Side



Parts List

Parts No.	Stock No.	Description	Position
TR01	0305732	2SC711 (F)	3 A
TR02	0305732	2SC711 (F)	3 A
TR03	0305732	2SC711 (F)	3 A
TR04	0305732	2SC711 (F)	3 A
TR05	0305732	2SC711 (F)	3 B
TR06	0305732	2SC711 (F)	3 B
TR07	0305475	2SC871 (H)(F)	2 B
TR08	0305475	2SC871 (H)(F)	1 A, B
TR601	0305732	2SC711 (F)	3 B
TR602	0305475	2SC871 (H)(F)	1 B
FET01	0370140, 1	2SK34 (E, D)	2 A
FET02	0370140, 1	2SK34 (E, D)	1 A
D01	0311190	1S34	3 A
D02	0311190	1S34	3 A
D03	0311190	1S34	3 A
D04	0311190	1S34	3 A
D05	0311180 or 0311160	1S1588 1S2473D	3 A
D06	0311180 or 0311160	1S1588 1S2473D	3 A
D07	0311180 or 0311160	1S1588 1S2473D	3 A
D08	0311180 or 0311160	1S1588 1S2473D	3 A
C01	0600106	0.001 μ F	3 A
C02	0600106	0.001 μ F	3 A
C03	0600206	0.002 μ F	3 A
C04	0600206	0.002 μ F	3 A
C05	0600477	0.047 μ F	3 A
C06	0600477	0.047 μ F	3 A
C07	0600206	0.002 μ F	3 A
C08	0600206	0.002 μ F	3 A
C09	0600477	0.047 μ F	3 A
C10	0600477	0.047 μ F	2 A
C11	0573228	0.22 μ F	3 A
C12	0573228	0.22 μ F	3 A
C13	0513479	4.7 μ F	3 A, B
C14	0513479	4.7 μ F	3 A, B
C15	0600477	0.047 μ F	3 B
C16	0600477	0.047 μ F	3 B
C17	0513100	10 μ F	2 A
C18	0513100	10 μ F	1 B
C19	0600397	0.039 μ F	2 A
C20	0600187	0.018 μ F	1 A
C21	0513100	10 μ F	2 B
C22	0513100	10 μ F	1 B
C23	0513479	4.7 μ F	2 A, B
C24	0513479	4.7 μ F	1 A
C25	0600226	0.0022 μ F	2 A
C26	0600226	0.0022 μ F	1 A
C27	0600477	0.047 μ F	2 B
C28	0600227	0.022 μ F	1 A, B
C29	0620681	680pF	2 B
C30	0620681	680pF	1 B
C31	0600397	0.039 μ F	2 A, B
C32	0600397	0.039 μ F	1 A

Parts No.	Stock No.	Description	Position
C33	0513479	4.7 μ F 25V	2 A, B
C34	0513479	4.7 μ F 25V	1 A
C601	0510101	100 μ F 6.3V	3 B
C602	0510101	100 μ F 6.3V	3 B
C603	0513479	4.7 μ F 25V	3 B
C604	0519102	3.3 μ F 50V	1 B
C605	0600476	0.0047 μ F 50V	M.C. 1 B
R01	0106683	68k Ω	3 A
R02	0106683	68k Ω	3 A
R03	0106105	1M Ω	3 A
R04	0106105	1M Ω	3 A
R05	0106224	220k Ω	3 A
R06	0106224	220k Ω	3 A
R07	0106223	22k Ω	3 A
R08	0106223	22k Ω	3 A
R09	0106103	10k Ω	3 A
R10	0106103	10k Ω	3 A
R11	0106472	4.7k Ω	3 A
R12	0106472	4.7k Ω	3 A
R13	0106472	4.7k Ω	3 A
R14	0106472	4.7k Ω	3 A
R15	0106333	33k Ω	3 A
R16	0106333	33k Ω	3 A
R17	0110685	6.8M Ω	3 A
R18	0110685	6.8M Ω	3 A
R19	0106104	100k Ω	3 B
R20	0106224	220k Ω	3 B
R21	0106153	15k Ω	3 A, B
R22	0106333	33k Ω	3 A, B
R23	0106123	12k Ω	3 A, B
R24	0106123	12k Ω	3 A, B
R25	0106472	4.7k Ω	3 B
R26	0106472	4.7k Ω	3 B
R27	0106102	1k Ω	3 B
R28	0106102	1k Ω	3 B
R29	0107104	100k Ω	3 B
R30	0106104	100k Ω	3 B
R31	0107104	100k Ω	3 B
R32	0106104	100k Ω	3 B
R33	0106564	560k Ω	2 B
R34	0106564	560k Ω	1 B
R35	0106224	220k Ω	2 B
R36	0106224	220k Ω	1 B
R37	0106474	470k Ω	2 B
R38	0106474	470k Ω	1 B
R39	0107334	330k Ω	2 A
R40	0106334	330k Ω	1 A
R41	0106682	6.8k Ω	2 A
R42	0106682	6.8k Ω	2 A
R43	0106183	18k Ω	2 A
R44	0106183	18k Ω	1 A
R45	0106105	1M Ω	2 A
R46	0106105	1M Ω	1 A
R47	0107153	15k Ω	2 B
R48	0107473	47k Ω	1 B
R49	0106103	10k Ω	2 B
R50	0106103	10k Ω	1 B
R51	0106105	1M Ω	2 A
R52	0106105	1M Ω	1 A
R53	0107333	33k Ω	2 A
R54	0107333	33k Ω	1 A

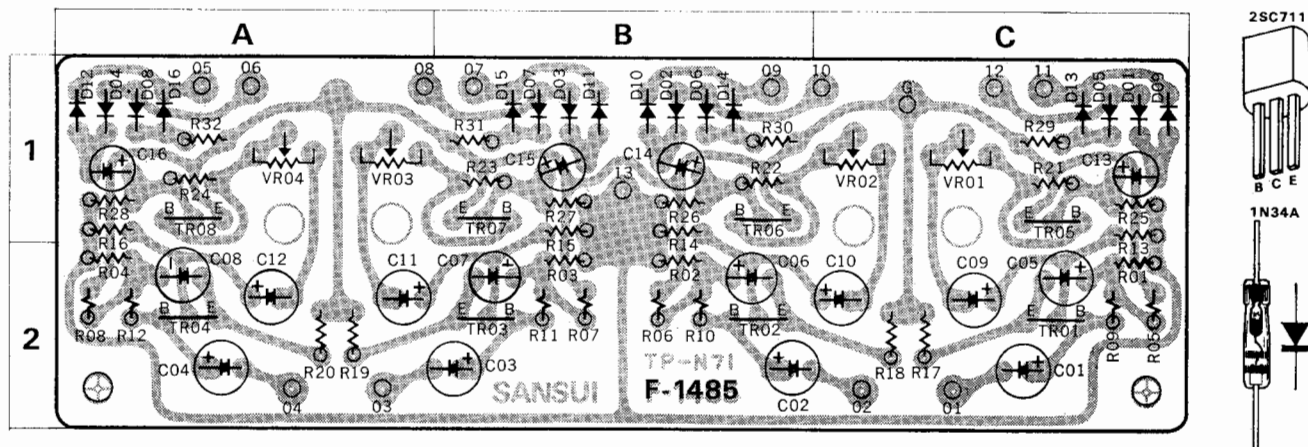
Parts No.	Stock No.	Description	Position
R55	0106153	15k Ω	2 A
R56	0106153	15k Ω	1 A
R57	0106123	12k Ω	2 A
R58	0106123	12k Ω	1 A
R59	0107153	15k Ω	2 B
R60	0107153	15k Ω	1 B
R61	0106151	150 Ω	2 A, B
R62	0107151	150 Ω	1 A
R63	0107104	100k Ω	2 B
R64	0106104	100k Ω	1 B
R65	0107184	180k Ω	2 B
R66	0106154	150k Ω	1 B
R67	0107473	47k Ω	2 B
R68	0107473	47k Ω	1 A, B
R69	0107472	4.7k Ω	2 B
R70	0106472	4.7k Ω	1 B
R71	0107222	2.2k Ω	2 B
R72	0107272	2.7k Ω	1 A
R73	0107101	100 Ω	2 A
R74	0107101	100 Ω	1 A
R601	0106105	1M Ω	3 A
R602	0106472	4.7k Ω	3 B
R603	0106102	1k Ω	3 B
R604	0107224	220k Ω	3 B
R605	0106333	33k Ω	3 B
R606	0106104	100k Ω	2 B
R607	0106104	100k Ω	2 B
R608	0106224	220k Ω	1 B
R609	0107104	100k Ω	1 B
R610	0106152	1.5k Ω	1 B
R611	0107152	1.5k Ω	1 B
R612	0106472	4.7k Ω	1 B
VR01	1031120	20k Ω (B)	2 A
VR02	1031120	20k Ω (B)	1 A
VR03	1031120	20k Ω (B)	2 A
VR04	1031120	20k Ω (B)	1 A
VR05	1031180	1M Ω (B)	2 A
VR06	1031180	1M Ω (B)	1 A
VR07	1031140	100k Ω (B)	2 B
VR08	1031140	100k Ω (B)	1 B
2260010	A4-01775	Test Pin	

Abbreviations:

C.R. : Carbon Resistor	BP.E.C.: Bi-Pola Electrolytic Capacitor
S.R. : Solid Resistor	C.C. : Ceramic Capacitor
Ce.R. : Cement Resistor	Mi.C. : Mica Capacitor
M.R. : Metallized Film Resistor	O.C. : Oil Capacitor
M.C. : Mylar Capacitor	P.C. : Polystyrene Capacitor
E.C. : Electrolytic Capacitor	T.C. : Tantalum Capacitor

6-7. F-1485 Meter Circuit Board (Stock No. 7591840 Complete Circuit Board F-1485)

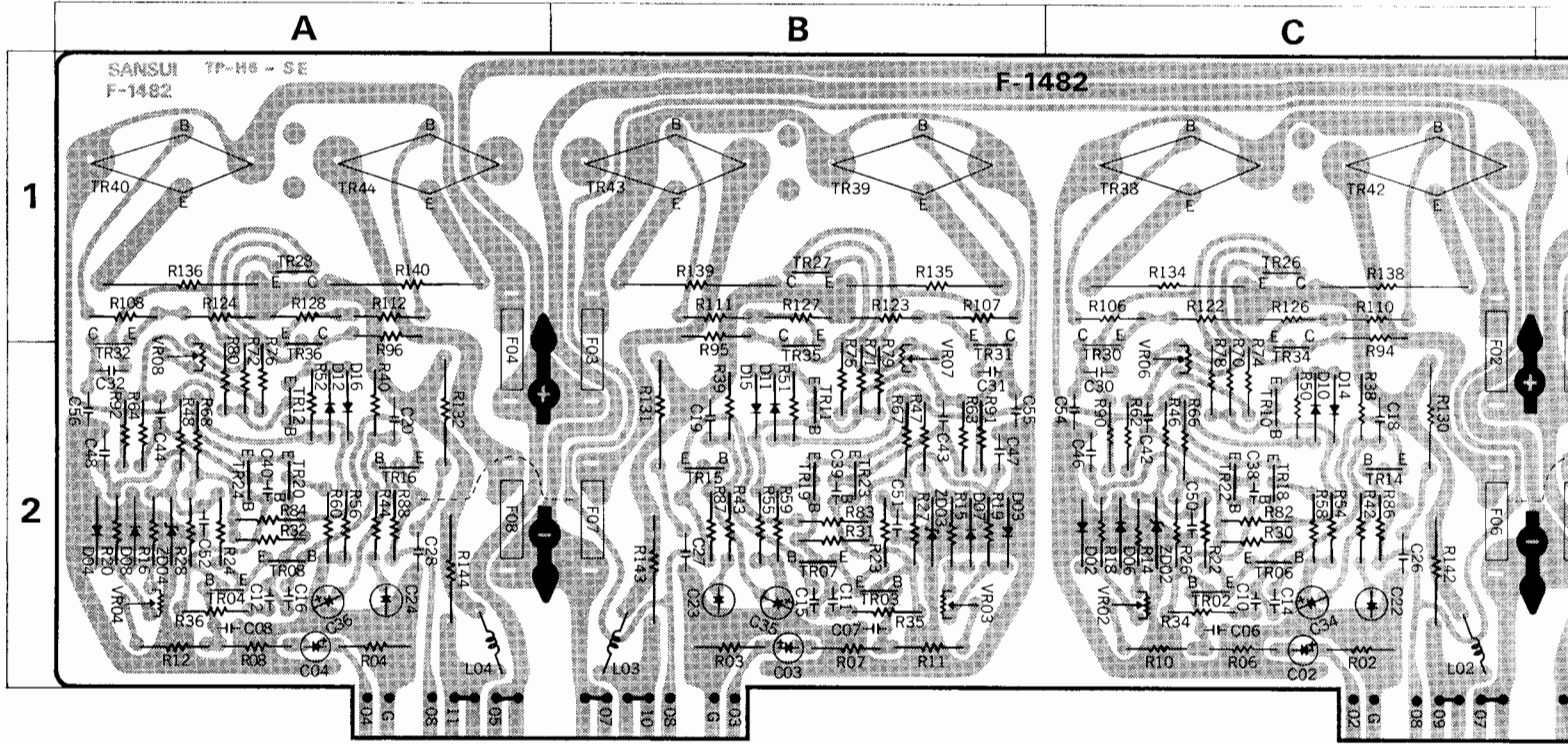
Conductor Side



Parts List

Parts No.	Stock No.	Description	Position	Parts No.	Stock No.	Description	Position
TR01	0305732	2SC711 (F)	2 C	C15	0519103	0.47 μ F	1 B
TR02	0305732	2SC711 (F)	2 B	C16	0519103	0.47 μ F	50V E.C. 1 A
TR03	0305732	2SC711 (F)	2 B	R01	0106824	820k Ω	2 C
TR04	0305732	2SC711 (F)	2 A	R02	0106824	820k Ω	2 B
TR05	0305732	2SC711 (F)	1 C	R03	0106824	820k Ω	2 B
TR06	0305732	2SC711 (F)	1 B	R04	0106824	820k Ω	2 A
TR07	0305732	2SC711 (F)	1 B	R05	0106104	100k Ω	2 C
TR08	0305732	2SC711 (F)	1 A	R06	0106104	100k Ω	2 B
D01	0310400	1N34A	1 C	R07	0106104	100k Ω	2 B
D02	0310400	1N34A	1 B	R08	0106104	100k Ω	2 A
D03	0310400	1N34A	1 B	R09	0106474	470k Ω	2 C
D04	0310400	1N34A	1 A	R10	0106474	470k Ω	2 B
D05	0310400	1N34A	1 C	R11	0106474	470k Ω	2 B
D06	0310400	1N34A	1 B	R12	0106474	470k Ω	2 A
D07	0310400	1N34A	1 B	R13	0106104	100k Ω	1 C
D08	0310400	1N34A	1 A	R14	0106104	100k Ω	1 B
D09	0310400	1N34A	1 C	R15	0106104	100k Ω	1 B
D10	0310400	1N34A	1 B	R16	0106104	100k Ω	1 A
D11	0310400	1N34A	1 B	R17	0106103	10k Ω	2 C
D12	0310400	1N34A	1 A	R18	0106103	10k Ω	2 C
D13	0310400	1N34A	1 C	R19	0106103	10k Ω	2 A
D14	0310400	1N34A	1 B	R20	0106103	10k Ω	2 A
D15	0310400	1N34A	1 B	R21	0106105	1M Ω	1 C
D16	0310400	1N34A	1 A	R22	0106105	1M Ω	1 B
C01	0515109	1 μ F	2 C	R23	0106105	1M Ω	1 B
C02	0515109	1 μ F	2 B	R24	0106105	1M Ω	1 A
C03	0515109	1 μ F	2 B	R25	0106472	4.7k Ω	1 C
C04	0515109	1 μ F	2 A	R26	0106472	4.7k Ω	1 B
C05	0515109	1 μ F	2 C	R27	0106472	4.7k Ω	1 B
C06	0515109	1 μ F	2 B	R28	0106472	4.7k Ω	1 A
C07	0515109	1 μ F	2 B	R29	0106822	8.2k Ω	1 C
C08	0515109	1 μ F	2 A	R30	0106822	8.2k Ω	1 B
C09	0515109	1 μ F	2 C	R31	0106822	8.2k Ω	1 B
C10	0515109	1 μ F	2 C	R32	0106822	8.2k Ω	1 A
C11	0515109	1 μ F	2 A	VR01	1032151	200k Ω (B)	1 C
C12	0515109	1 μ F	2 A	VR02	1032151	200k Ω (B)	1 C
C13	0519103	0.47 μ F	1 C	VR03	1032151	200k Ω (B)	1 A
C14	0519103	0.47 μ F	1 B	VR04	1032151	200k Ω (B)	1 A

6-8. F-1482 Driver Circuit Board (Stock No. 7570790 Complete Circuit Board F-1482)
Conductor Side



Parts List

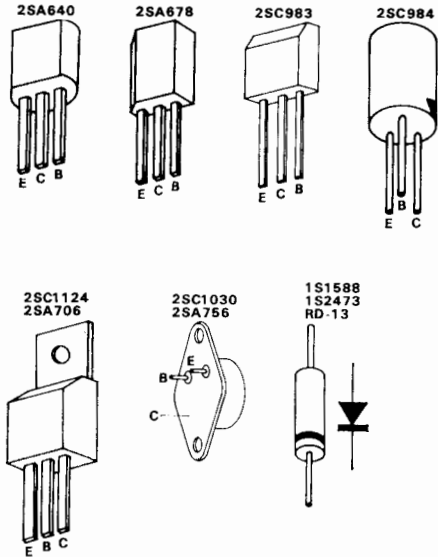
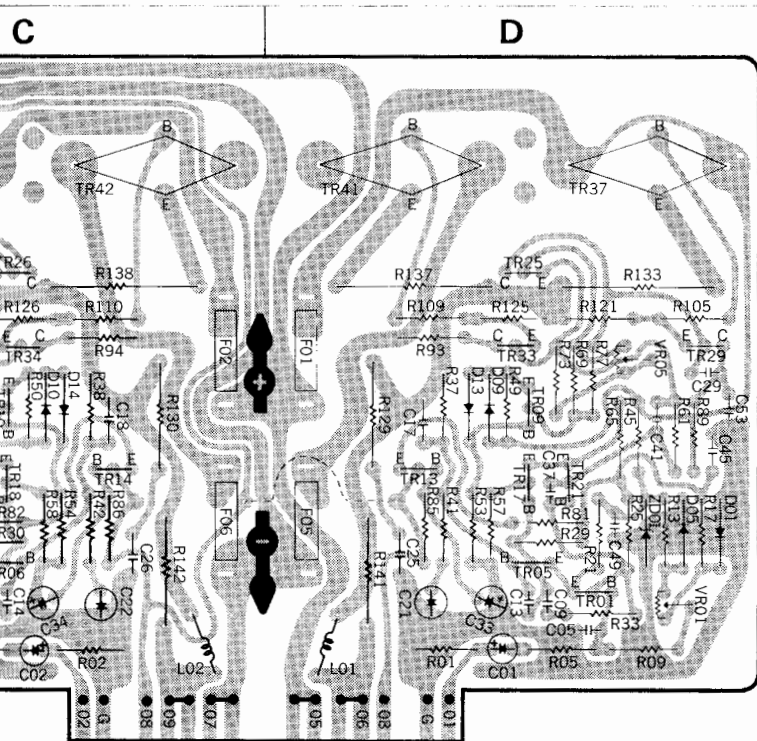
Parts No.	Stock No.	Description	Position
TR01	0300302, 4	2SA640 (L1, L3)	2 D
TR02	0300302, 4	2SA640 (L1, L3)	2 C
TR03	0300302, 4	2SA640 (L1, L3)	2 B
TR04	0300302, 4	2SA640 (L1, L3)	2 A
TR05	0300302, 4	2SA640 (L1, L3)	2 D
TR06	0300302, 4	2SA640 (L1, L3)	2 C
TR07	0300302, 4	2SA640 (L1, L3)	2 B
TR08	0300302, 4	2SA640 (L1, L3)	2 A
TR09	0300291, 2	2SA678 (6, 7)	2 D
TR10	0300291, 2	2SA678 (6, 7)	2 C
TR11	0300291, 2	2SA678 (6, 7)	2 B
TR12	0300291, 2	2SA678 (6, 7)	2 A
TR13	0300291, 2	2SA678 (6, 7)	2 D
TR14	0300291, 2	2SA678 (6, 7)	2 C
TR15	0300291, 2	2SA678 (6, 7)	2 B
TR16	0300291, 2	2SA678 (6, 7)	2 A
TR17	0306020, 1	2SC983 (R, 0)	2 D
TR18	0306020, 1	2SC983 (R, 0)	2 C
TR19	0306020, 1	2SC983 (R, 0)	2 B
TR20	0306020, 1	2SC983 (R, 0)	2 A
TR21	0306020, 1	2SC983 (R, 0)	2 D
TR22	0306020, 1	2SC983 (R, 0)	2 C
TR23	0306020, 1	2SC983 (R, 0)	2 B
TR24	0306020, 1	2SC983 (R, 0)	2 A
TR25	0305872	2SC984 (C)	1 D
TR26	0305872	2SC984 (C)	1 C
TR27	0305872	2SC984 (C)	1 B
TR28	0305872	2SC984 (C)	1 A
TR29	0305901	2SC1124 (2)	1, 2 D
TR30	0305901	2SC1124 (2)	1, 2 C

Parts No.	Stock No.	Description	Position
TR31	0305901	2SC1124 (2)	1, 2 B
TR32	0305901	2SC1124 (2)	1, 2 A
TR33	0300401	2SA706 (2)	1, 2 D
TR34	0300401	2SA706 (2)	1, 2 C
TR35	0300401	2SA706 (2)	1, 2 B
TR36	0300401	2SA706 (2)	1, 2 A
TR37	0305631	2SC1030 (B)	1 D
TR38	3103056	2SC1030 (B)	1 C
TR39	0305631	2SC1030 (B)	1 B
TR40	0305631	2SC1030 (B)	1 A
TR41	0300551	2SA756 (B)	1 D
TR42	0300551	2SA756 (B)	1 C
TR43	0300551	2SA756 (B)	1 B
TR44	0300551	2SA756 (B)	1 A
D01	{ 0311060 or 0311080	{ 1S2473 or 1S1588	2 D
D02	{ 0311060 or 0311080	{ 1S2473 or 1S1588	2 C
D03	{ 0311060 or 0311080	{ 1S2473 or 1S1588	2 B
D04	{ 0311060 or 0311080	{ 1S2473 or 1S1588	2 A
D05	{ 0311060 or 0311080	{ 1S2473 or 1S1588	2 D
D06	{ 0311060 or 0311080	{ 1S2473 or 1S1588	2 C

Transistor

Transistor

Diode



Position	Parts No.	Stock No.	Description	Position
2B	D07	0311060	1S2473	2B
		or	or	
2A	D08	0311080	1S1588	2A
		or	or	
2D	D09	0311060	1S2473	2D
		or	or	
2C	D10	0311080	1S1588	2C
		or	or	
2B	D11	0311060	1S2473	2B
		or	or	
2A	D12	0311080	1S1588	2A
		or	or	
2D	D13	0311060	1S2473	2D
		or	or	
2C	D14	0311080	1S1588	2C
		or	or	
2B	D15	0311060	1S2473	2B
		or	or	
2A	D16	0311080	1S1588	2A
		or	or	
2D	ZD01	0315300	RD-13 (M)	2D
		or	or	
		or	or	
		or	or	
2C	ZD02	0315300	RD-13 (M)	2C
		or	or	
		or	or	
		or	or	
2B	ZD03	0315300	RD-13 (M)	2B
		or	or	
		or	or	
		or	or	
2A	ZD04	0315300	RD-13 (M)	2A
		or	or	
		or	or	
		or	or	

Parts No.	Stock No.	Description	Position	
L01	4290210	2R5K 2.5 μ H \pm 10%	Filter Coil 2D	
L02	4290210	2R5K 2.5 μ H \pm 10%		2C
L03	4290210	2R5K 2.5 μ H \pm 10%		2B
L04	4290210	2R5K 2.5 μ H \pm 10%		2A
C01	0519102	3.3 μ F	\pm 10% 50V E.C.	
C02	0519102	3.3 μ F		2C
C03	0519102	3.3 μ F		2B
C04	0519102	3.3 μ F		2A
C05	0660680	68pF	\pm 10% 50V C.C.	
C06	0660680	68pF		2D
C07	0660680	68pF		2C
C08	0660680	68pF		2B
C09	0600106	0.001 μ F	\pm 5% 50V M.C.	
C10	0600106	0.001 μ F		2D
C11	0600106	0.001 μ F		2C
C12	0600106	0.001 μ F		2A
C13	0660330	33pF	\pm 10% 50V C.C.	
C14	0660330	33pF		2D
C15	0660330	33pF		2C
C16	0660330	33pF		2B
C17	0660150	1.5pF	2A	
C18	0660150	1.5pF		2D

Abbreviations

- C.R.** : Carbon Resistor
- S.R.** : Solid Resistor
- Ce.R.** : Cement Resistor
- M.R.** : Metallized Film Resistor
- M.C.** : Mylar Capacitor
- E.C.** : Electrolytic Capacitor
- BP.E.C.:** Bi-Pola Electrolytic Capacitor
- C.C.** : Ceramic Capacitor
- Mi.C.** : Mica Capacitor
- O.C.** : Oil Capacitor
- P.C.** : Polystyrene Capacitor
- T.C.** : Tantalum Capacitor

Parts No.	Stock No.	Description	Position
C19	0660150	15pF	±10% 50V E.C. 2B
C20	0660150	15pF	
C21	0531101	100 μ F	10V BP.E.C. 2D
C22	0531101	100 μ F	
C23	0531101	100 μ F	
C24	0531101	100 μ F	
C25	0600107	0.1 μ F	
C26	0600107	0.1 μ F	±5% 50V M.C. 2C
C27	0600107	0.1 μ F	
C28	0600107	0.1 μ F	
C29	0660470	470pF	±10% 50V C.C. 2D
C30	0660470	470pF	
C31	0660470	470pF	
C32	0660470	470pF	
C33	0515330	33 μ F	
C34	0515330	33 μ F	50V E.C. 2C
C35	0515330	33 μ F	
C36	0515330	33 μ F	
C37	0660220	22pF	±10% 50V C.C. 2D
C38	0660220	22pF	
C39	0660220	22pF	
C40	0660220	22pF	
C41	0657222	0.0022 μ F	
C42	0657222	0.0022 μ F	
C43	0657222	0.0022 μ F	
C44	0657222	0.0022 μ F	
C45	0657473	0.047 μ F	±10% 50V C.C. 2D
C46	0657473	0.047 μ F	
C47	0657473	0.047 μ F	
C48	0657473	0.047 μ F	
C49	0657473	0.047 μ F	
C50	0657473	0.047 μ F	
C51	0657473	0.047 μ F	
C52	0657473	0.047 μ F	
C53	0657473	0.047 μ F	
C54	0657473	0.047 μ F	
C55	0657473	0.047 μ F	
C56	0657473	0.047 μ F	
R01	0107154	150k Ω	±5% 1/4W C.R. 2D
R02	0107154	150k Ω	
R03	0107154	150k Ω	
R04	0107154	150k Ω	
R05	0107103	10k Ω	
R06	0107103	10k Ω	
R07	0107103	10k Ω	
R08	0107103	10k Ω	
R09	0107104	100k Ω	
R10	0107104	100k Ω	
R11	0107104	100k Ω	±5% 1/4W C.R. 2A
R12	0107104	100k Ω	
R13	0107822	8.2k Ω	
R14	0107822	8.2k Ω	
R15	0107822	8.2k Ω	
R16	0107822	8.2k Ω	
R17	0107473	47k Ω	
R18	0107473	47k Ω	
R19	0107473	47k Ω	
R20	0107473	47k Ω	
R21	0107103	10k Ω	±5% 1/4W C.R. 2D
R22	0107103	10k Ω	
R23	0107103	10k Ω	

Parts No.	Stock No.	Description	Position
R24	0107103	10k Ω	2A
R25	0107682	6.8k Ω	2D
R26	0107682	6.8k Ω	2C
R27	0107682	6.8k Ω	2B
R28	0107682	6.8k Ω	2A
R29	0107682	6.8k Ω	2D
R30	0107682	6.8k Ω	2C
R31	0107682	6.8k Ω	2B
R32	0107682	6.8k Ω	2A
R33	0107221	220 Ω	2D
R34	0107221	220 Ω	2C
R35	0107221	220 Ω	2B
R36	0107221	220 Ω	2A
R37	0107683	68k Ω	2D
R38	0107683	68k Ω	2C
R39	0107683	68k Ω	2B
R40	0107683	68k Ω	2A
R41	0107392	3.9k Ω	2D
R42	0107392	3.9k Ω	2C
R43	0107392	3.9k Ω	2B
R44	0107392	3.9k Ω	2A
R45	0107822	8.2k Ω	2D
R46	0107822	8.2k Ω	2C
R47	0107822	8.2k Ω	2B
R48	0107822	8.2k Ω	2A
R49	0107471	470 Ω	2D
R50	0107471	470 Ω	2C
R51	0107471	470 Ω	2B
R52	0107471	470 Ω	2A
R53	0107473	47k Ω	2D
R54	0107473	47k Ω	2C
R55	0107473	47k Ω	2B
R56	0107473	47k Ω	2A
R57	0107101	100 Ω	2D
R58	0107101	100 Ω	2C
R59	0107101	100 Ω	2B
R60	0107101	100 Ω	2A
R61	0107101	100 Ω	2D
R62	0107101	100 Ω	2C
R63	0107101	100 Ω	2B
R64	0107101	100 Ω	2A
R65	0103471	470 Ω	2D
R66	0103471	470 Ω	2C
R67	0103471	470 Ω	2B
R68	0103471	470 Ω	2A
R69	0107562	5.6k Ω	2D
R70	0107562	5.6k Ω	2C
R71	0107562	5.6k Ω	2B
R72	0107562	5.6k Ω	2A
R73	0107152	1.5k Ω	2D
R74	0107152	1.5k Ω	2C
R75	0107152	1.5k Ω	2B
R76	0107152	1.5k Ω	2A
R77	0107330	33 Ω	2D
R78	0107330	33 Ω	2C
R79	0107330	33 Ω	2B
R80	0107330	33 Ω	2A
R81	0107689	6.8 Ω	2D
R82	0107689	6.8 Ω	2C
R83	0107689	6.8 Ω	2B
R84	0107689	6.8 Ω	2A
R85	0107472	4.7k Ω	2D

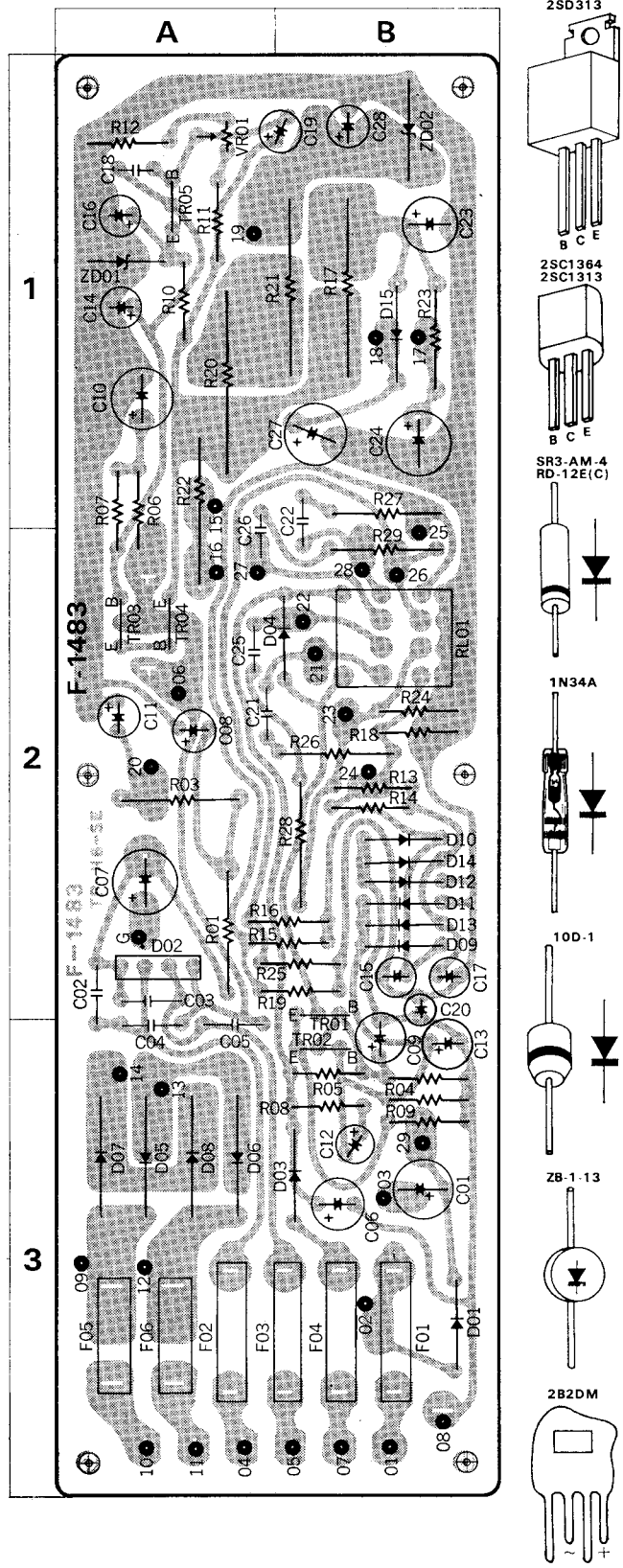
F-1482 Parts List

Parts No.	Stock No.	Description	Position
R86	0107472	4.7kΩ	2C
R87	0107472	4.7kΩ	2B
R88	0107472	4.7kΩ	2A
R89	0107100	10Ω	2D
R90	0107100	10Ω	2C
R91	0107100	10Ω	2B
R92	0107100	10Ω	2A
R93	0107100	10Ω	1D
R94	0107100	10Ω	1C
R95	0107100	10Ω	1B
R96	0107100	10Ω	1A
R105	0107689	6.8Ω	1D
R106	0107689	6.8Ω	1C
R107	0107689	6.8Ω	1B
R108	0107689	6.8Ω	1A
R109	0107689	6.8Ω	1D
R110	0107689	6.8Ω	1C
R111	0107689	6.8Ω	1B
R112	0107689	6.8Ω	1A
R121	0107221	220Ω	1D
R122	0107221	220Ω	1C
R123	0107221	220Ω	1B
R124	0107221	220Ω	1A
R125	0107221	220Ω	1D
R126	0107221	220Ω	1C
R127	0107221	220Ω	1B
R128	0107221	220Ω	1A
R129	0132479	4.7Ω	2D
R130	0132479	4.7Ω	2C
R131	0132479	4.7Ω	2B
R132	0132479	4.7Ω	2A
R133	0133478	0.47Ω	1D
R134	0133478	0.47Ω	1C
R135	0133478	0.47Ω	1B
R136	0133478	0.47Ω	1A
R137	0133478	0.47Ω	1D
R138	0133478	0.47Ω	1C
R139	0133478	0.47Ω	1B
R140	0133478	0.47Ω	1A
R141	0132479	4.7Ω	2D
R142	0132479	4.7Ω	2C
R143	0132479	4.7Ω	2B
R144	0132479	4.7Ω	2A
VR01	1035110	4.7kΩ (B)	2D
VR02	1035110	4.7kΩ (B)	2C
VR03	1035110	4.7kΩ (B)	2B
VR04	1035110	4.7kΩ (B)	2A
VR05	1035070	1kΩ (B)	2D
VR06	1035070	1kΩ (B)	2C
VR07	1035070	1kΩ (B)	2B
VR08	1035070	1kΩ (B)	2A
F01	0433680	3.5A Quick-acting Fuse	1, 2 D
F02	0433680	3.5A Quick-acting Fuse	1, 2 C
F03	0433680	3.5A Quick-acting Fuse	1, 2 B
F04	0433680	3.5A Quick-acting Fuse	1, 2 A
F05	0433680	3.5A Quick-acting Fuse	2D
F06	0433680	3.5A Quick-acting Fuse	2C
F07	0433680	3.5A Quick-acting Fuse	2B
F08	0433680	3.5A Quick-acting Fuse	2A
2310150	Fuse Holder		

6-9. F-1483 Protector & Power Circuit Board

(Stock No. 7500870 Complete Circuit Board F-1483)

Conductor Side



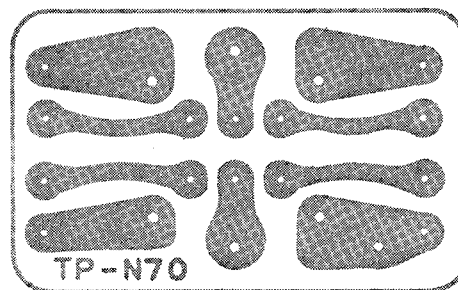
Parts No.	Stock No.	Description	Position
TR01	0305891, 2	2SC634A (6, 7)	} Transistor 2 A
TR02	0305891, 2	2SC634A (6, 7)	
TR03	0305930, 1	2SC1211 (C, D)	
TR04	0308392, 3	2SD313 (E, F)	
TR05	0306070, 1	2SC1313 (F, G)	
	or	or	1 A
	0306132, 3	2SC1364 (7, 8)	
D01	0310340	10D-1	} Diode 3 A
D02	0311070	2B2DM	
D03	0310340	10D-1	
D04	0310340	10D-1	
D05	0311240	SR3-AM-4	
D06	0311240	SR3-AM-4	
D07	0311240	SR3-AM-4	
D08	0311240	SR3-AM-4	
D09	0310400	1N34A	
D10	0310400	1N34A	
D11	0310400	1N34A	
D12	0310400	1N34A	
D13	0310400	1N34A	
D14	0310400	1N34A	
D15	0310340	10D-1	
ZD01	0316300	RD-12E (C)	} Zener Diode 1 A
ZD02	0315090	ZB-1-13	
RL01	1150101	MY4-0-US-SA Relay	2 B
C01	0511102	1000 μ F	10V E.C. 3 B
C02	0659011	0.01 μ F	} 500V C.C. 2 A
C03	0659011	0.01 μ F	
C04	0659011	0.01 μ F	
C05	0659011	0.01 μ F	
C06	0515330	33 μ F	
C07	0519302	220 μ F	80V } 2 A
C08	0515101	100 μ F	50V } E.C. 2 A
C09	0510471	470 μ F	6.3V } 2, 3 B
C10	0519301	100 μ F	80V } 1 A
C11	0515470	47 μ F	2 A
C12	0519103	0.47 μ F	} 50V E.C. 3 B
C13	0515109	1 μ F	
C14	0515100	10 μ F	1 A
C15	0530470	47 μ F	6.3V } 2 B
C16	0512101	100 μ F	16V } E.C. 1 A
C17	0530470	47 μ F	6.3V } 2 B
C18	0660221	220pF	50V C.C. 1 A
C19	0515100	10 μ F	} 50V E.C. 1 A, B
C20	0535109	1 μ F	
C23	0515101	100 μ F	1 B
C24	0513331	330 μ F	} 25V E.C. 1 B
C27	0513331	330 μ F	
C28	0512221	220 μ F	16V E.C. 1 B
R01	0182681	680 Ω \pm 5 %	2 W Ce.R. 2 A
R02	0107479	4.7 Ω \pm 5 %	1/4 W C.R.
R04	0107562	5.6k Ω	} \pm 5 % 1/4 W C.R. 3 B
R05	0107823	82k Ω	
R06	0107562	5.6k Ω	
R07	0107332	3.3k Ω	
R08	0107394	390k Ω	
R09	0107474	470k Ω	

Parts No.	Stock No.	Description	Position	
R10	0107562	5.6k Ω	} \pm 5 % 1/4 W C.R. 1 A	
R11	0107223	22k Ω		
R12	0107822	8.2k Ω		
R13	0107473	47k Ω		
R14	0107473	47k Ω		
R15	0107473	47k Ω		
R16	0107473	47k Ω		
R17	0182331	300 Ω \pm 10 %		2 W Ce.R. 1 B
R18	0107332	3.3k Ω		} \pm 5 % 1/4 W C.R. 2 B
R19	0107332	3.3k Ω		
R22	0132101	100 Ω \pm 10 %	2 W Ce.R. 1, 2 A	
R23	0104220	22 Ω \pm 5 %	1 W } 1 B	
R24	0107332	3.3k Ω \pm 5 %	1/4 W } C.R. 2 B	
R25	0107332	3.3k Ω \pm 5 %	1/4 W } 2 A, B	
VR01	1035090	2.2k Ω (B) Solid Volume	1 A	
F01	0432900, 1	5A Wired-in Fuse	3 B	
F02	0432850, 1	2A Wired-in Fuse	3 A	
F03	0432850, 1	2A Wired-in Fuse	3 B	
F04	0432830, 1	1A Wired-in Fuse	3 B	
	2250020	Fasten Tab		

6-10. F-1490 De-emphasis Circuit Board

(Stock No. 7591880 Complete Circuit Board F-1490)

Conductor Side



Parts List

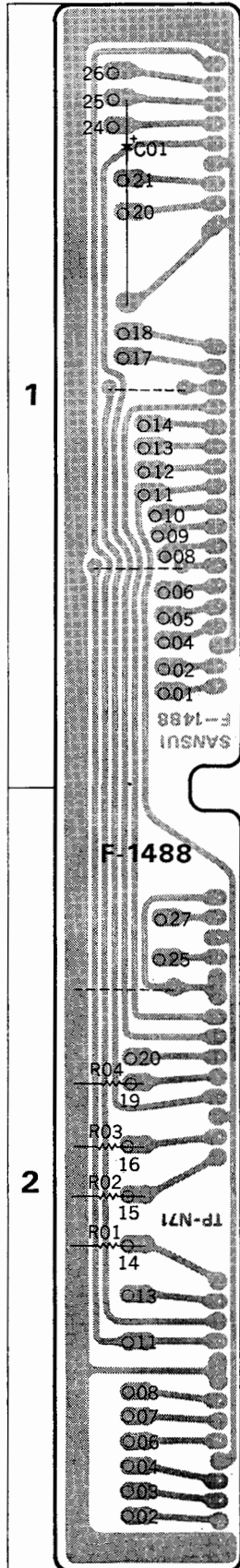
Parts No.	Stock No.	Description
C01	0600826	0.0082 μ F \pm 5 %
C02	0600826	0.0082 μ F \pm 5 %
S01, 02	1110240	Slide Switch

Abbreviations

C.R. : Carbon Resistor	BP.E.C.: Bi-Pola Electrolytic Capacitor
S.R. : Solid Resistor	C.C. : Ceramic Capacitor
Ce.R. : Cement Resistor	Mi.C. : Mica Capacitor
M.R. : Metallized Film Resistor	O.C. : Oil Capacitor
M.C. : Mylar Capacitor	P.C. : Polystyrene Capacitor
E.C. : Electrolytic Capacitor	T.C. : Tantalum Capacitor

6-11. F-1488 Connector Joint Circuit Board (Stock No. 7591860 Complete Circuit Board F-1488)

Conductor Side



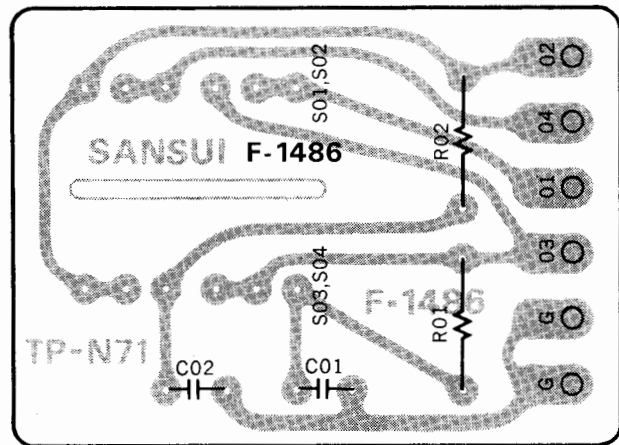
Parts List

Parts No.	Stock No.	Description	Position
C01	0504221	220 μ F 35V E.C.	1
R01	0107474	470k Ω	} $\pm 5\%$ $\frac{1}{4}$ W C.R.
R02	0107474	470k Ω	
R03	0107474	470k Ω	
R04	0107474	470k Ω	
	2420150	10P Connector	
	2420160	14P Connector	
	2420170	18P Connector	

6-12. F-1486 Filter Circuit Board

(Stock No. 7591830 Complete Circuit Board F-1486)

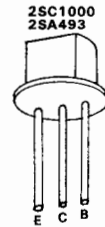
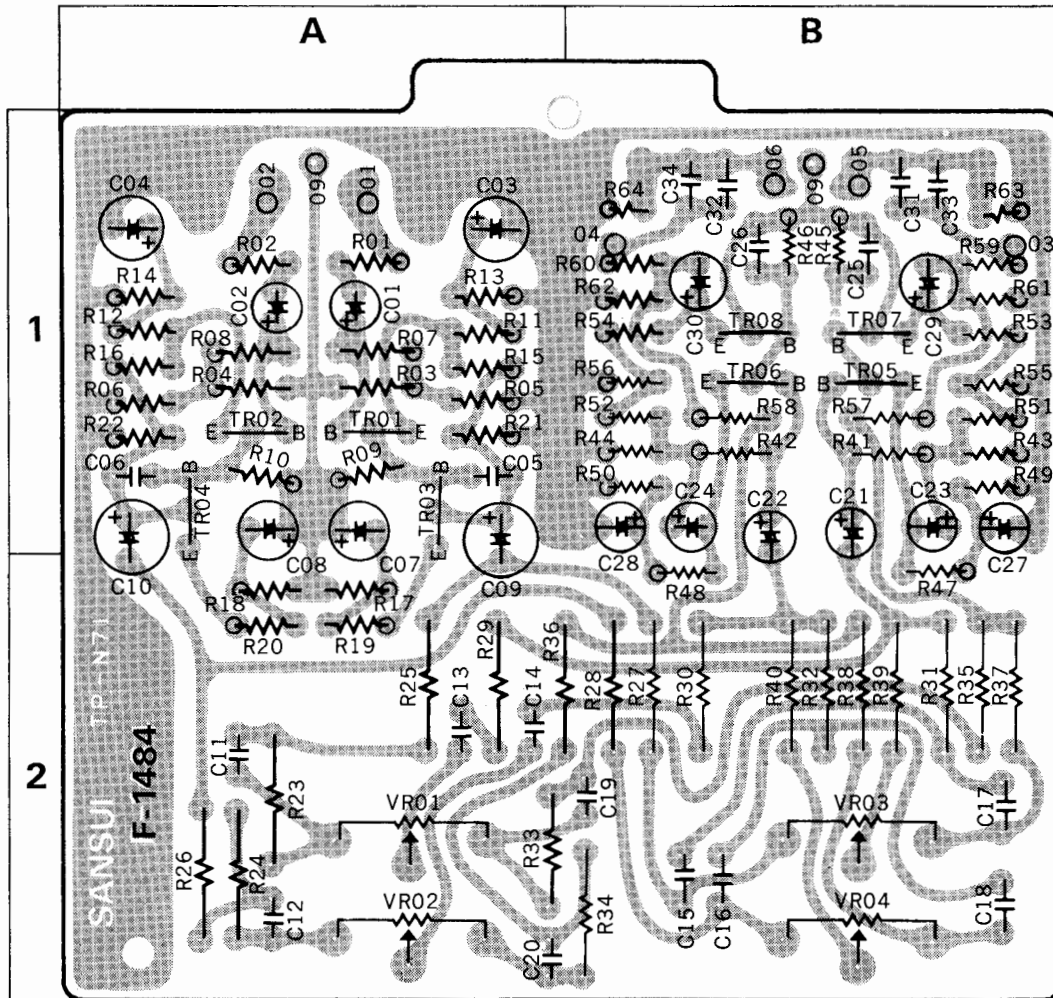
Conductor Side



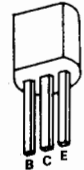
Parts List

Parts No.	Stock No.	Description
C01	0600187	0.018 μ F $\pm 5\%$ 50V M.C.
C02	0600187	0.018 μ F $\pm 5\%$ 50V M.C.
R01	0107824	820k Ω
R02	0107824	820k Ω
S01-04	1130760	Push Switch

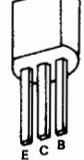
6-13. F-1484 Tone Control Circuit Board (Stock No. 7560740 Complete Circuit Board F-1484) Conductor Side



2SC1222
2SA726
2SC1313



2SC1222
2SA640



Parts List

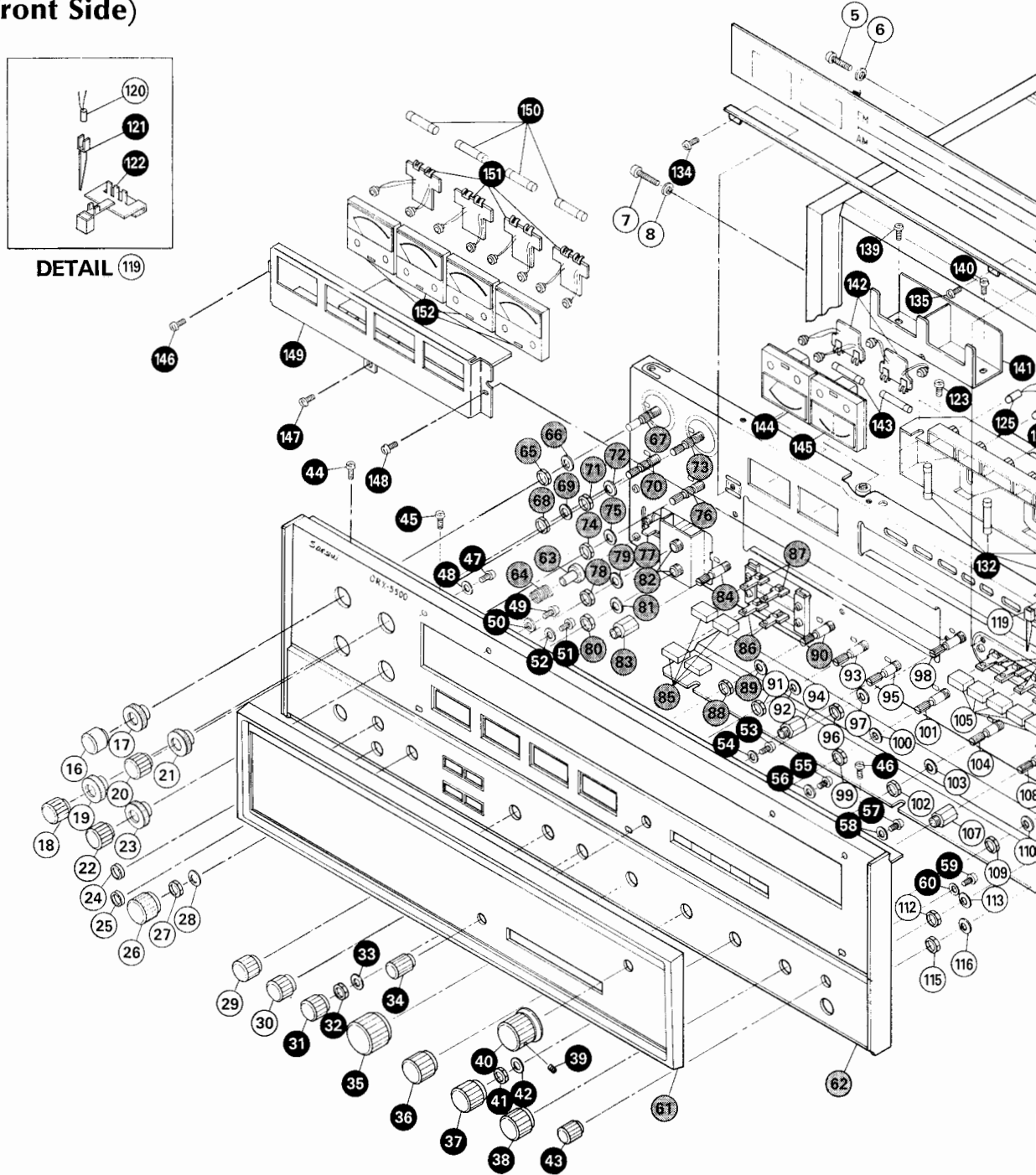
Parts No.	Stock No.	Description	Position	Parts No.	Stock No.	Description	Position
TR01	0305880, 1	2SC1000 (GR, BL)	1 A	TR06	0305880	2SC1000 (GR, BL)	1 B
	or				or		
	0306071, 2	2SC1313 (G, H)			or		
TR02	0306011, 2	2SC1222 (E, F)	1 A	TR07	0306011, 2	2SC1222 (E, F)	1 B
	0305880, 1	2SC1000 (GR, BL)			or		
	0336071, 2	2SC1313 (G, H)			or		
TR03	0306011, 2	2SC1222 (E, F)	1 A	TR08	0305880	2SC1000 (GR, BL)	1 B
	0300450	2SA493 (GR)			or		
	0300410, 1	2SA726 (F, G)			or		
TR04	0300302, 3	2SA640 (K, L)	1 A	TR09	0306071, 2	2SC1313 (G, H)	1 B
	0300450	2SA493 (GR)			or		
	0300410, 1	2SA726 (F, G)			or		
TR05	0300302, 3	2SA640 (K, L)	1 B	TR10	0305880	2SC1000 (GR, BL)	1 B
	0305880	2SC1000 (GR, BL)			or		
	0306071, 2	2SC1313 (G, H)			or		
		0306011, 2			0306011, 2	2SC1222 (E, F)	

Parts No.	Stock No.	Description	Position	Parts No.	Stock No.	Description	Position		
C01	0519101	1 μ F	50V E.C.	1 A	R33	0107224	220k Ω	2 A	
C02	0519101	1 μ F		1 A	R34	0107224	220k Ω	2 B	
C03	0512470	47 μ F	16V E.C.	1 A	R35	0107222	2.2k Ω	2 B	
C04	0512470	47 μ F		1 A	R36	0107222	2.2k Ω	± 5 % 1/4W C.R. 2 A, B	
C05	0660470	47 pF	50V C.C.	1 A	R37	0107183	18k Ω		2 B
C06	0660470	47 pF		1 A	R38	0107183	18k Ω	2 B	
C07	0512330	33 μ F	16V E.C.	1 A	R39	0107472	4.7k Ω	2 B	
C08	0512330	33 μ F		1 A	R40	0107472	4.7k Ω	2 B	
C09	0519102	3.3 μ F	50V E.C.	1, 2 A	R41	0106683	68k Ω	1 B	
C10	0519102	3.3 μ F		1, 2 A	R42	0106683	68k Ω	1 B	
C11	0600476	0.0047 μ F	± 5 % 50V M.C.	2 A	R43	0106394	390k Ω	1 B	
C12	0600476	0.0047 μ F		2 A	R44	0106394	390k Ω	1 B	
C13	0600826	0.0082 μ F		2 A	R45	0106563	56k Ω	1 B	
C14	0600826	0.0082 μ F		2 A	R46	0106563	56k Ω	1 B	
C15	0600227	0.022 μ F		2 B	R47	0106561	560 Ω	2 B	
C16	0600227	0.022 μ F		2 B	R48	0106561	560 Ω	2 B	
C17	0600227	0.022 μ F		2 B	R49	0106562	5.6k Ω	1 B	
C18	0600227	0.022 μ F		2 B	R50	0106562	5.6k Ω	1 B	
C19	0600476	0.0047 μ F		2 B	R51	0106154	150k Ω	1 B	
C20	0600476	0.0047 μ F		2 A	R52	0106154	150k Ω	± 5 % 1/4W C.R. (E.L.R.) 1 B	
C21	0519101	1 μ F	50V E.C.	1, 2 B	R53	0106682	6.8k Ω		1 B
C22	0519101	1 μ F		1, 2 B	R54	0106682	6.8k Ω	1 B	
C23	0512100	10 μ F	16V E.C.	1 B	R55	0106821	820 Ω	1 B	
C24	0512100	10 μ F		1 B	R56	0106821	820 Ω	1 B	
C25	0660470	47 pF	50V C.C.	1 B	R57	0106220	22 Ω	1 B	
C26	0660470	47 pF		1 B	R58	0106220	22 Ω	1 B	
C27	0512100	10 μ F	16V E.C.	1 B	R59	0106332	3.3k Ω	1 B	
C28	0512100	10 μ F		1 B	R60	0106332	3.3k Ω	1 B	
C29	0519101	1 μ F	50V E.C.	1 B	R61	0106563	56k Ω	1 B	
C30	0519101	1 μ F		1 B	R62	0106563	56k Ω	1 B	
R01	0106102	1k Ω	± 5 % 1/4W C.R. (E.L.R.)	1 A	R63	0106104	100k Ω	1 B	
R02	0106102	1k Ω		1 A	R64	0106104	100k Ω	1 B	
R03	0106474	470k Ω		1 A	VR01	1020250, 1	100k Ω (W) × 2	Variable Resistor 2 A	
R04	0106474	470k Ω		1 A	VR02	1020250, 1	100k Ω (W) × 2		2 A
R05	0106274	270k Ω		1 A	VR03	1020240, 1	100k Ω (B) × 2		2 B
R06	0106274	270k Ω		1 A	VR04	1020240, 1	100k Ω (B) × 2		2 B
R07	0106394	390k Ω		1 A					
R08	0106394	390k Ω		1 A					
R09	0106183	18k Ω		1 A					
R10	0106183	18k Ω		1 A					
R11	0106102	1k Ω		1 A					
R12	0106102	1k Ω		1 A					
R13	0106123	12k Ω		1 A					
R14	0106123	12k Ω		1 A					
R15	0106123	12k Ω		1 A					
R16	0106123	12k Ω		1 A					
R17	0106821	820 Ω		2 A					
R18	0106821	820 Ω		2 A					
R19	0106221	220 Ω		2 A					
R20	0106221	220 Ω		2 A					
R21	0106682	6.8k Ω		1 A					
R22	0106682	6.8k Ω		1 A					
R23	0107224	220k Ω		2 A					
R24	0107224	220k Ω		2 A					
R25	0107222	2.2k Ω		2 A					
R26	0107222	2.2k Ω		2 A					
R27	0107183	18k Ω		± 5 % 1/4W C.R.	2 B				
R28	0107183	18k Ω			2 B				
R29	0107222	2.2k Ω		2 A					
R30	0107222	2.2k Ω		2 B					
R31	0107472	4.7k Ω	2 B						
R32	0107472	4.7k Ω	2 B						

— Abbreviations —

C.R. : Carbon Resistor	BP.E.C.: Bi-Pola Electrolytic Capacitor
S.R. : Solid Resistor	C.C. : Ceramic Capacitor
Ce.R. : Cement Resistor	Mi.C. : Mica Capacitor
M.R. : Metallized Film Resistor	O.C. : Oil Capacitor
M.C. : Mylar Capacitor	P.C. : Polystyrene Capacitor
E.C. : Electrolytic Capacitor	T.C. : Tantalum Capacitor

6-14. Other Parts (Front Side)

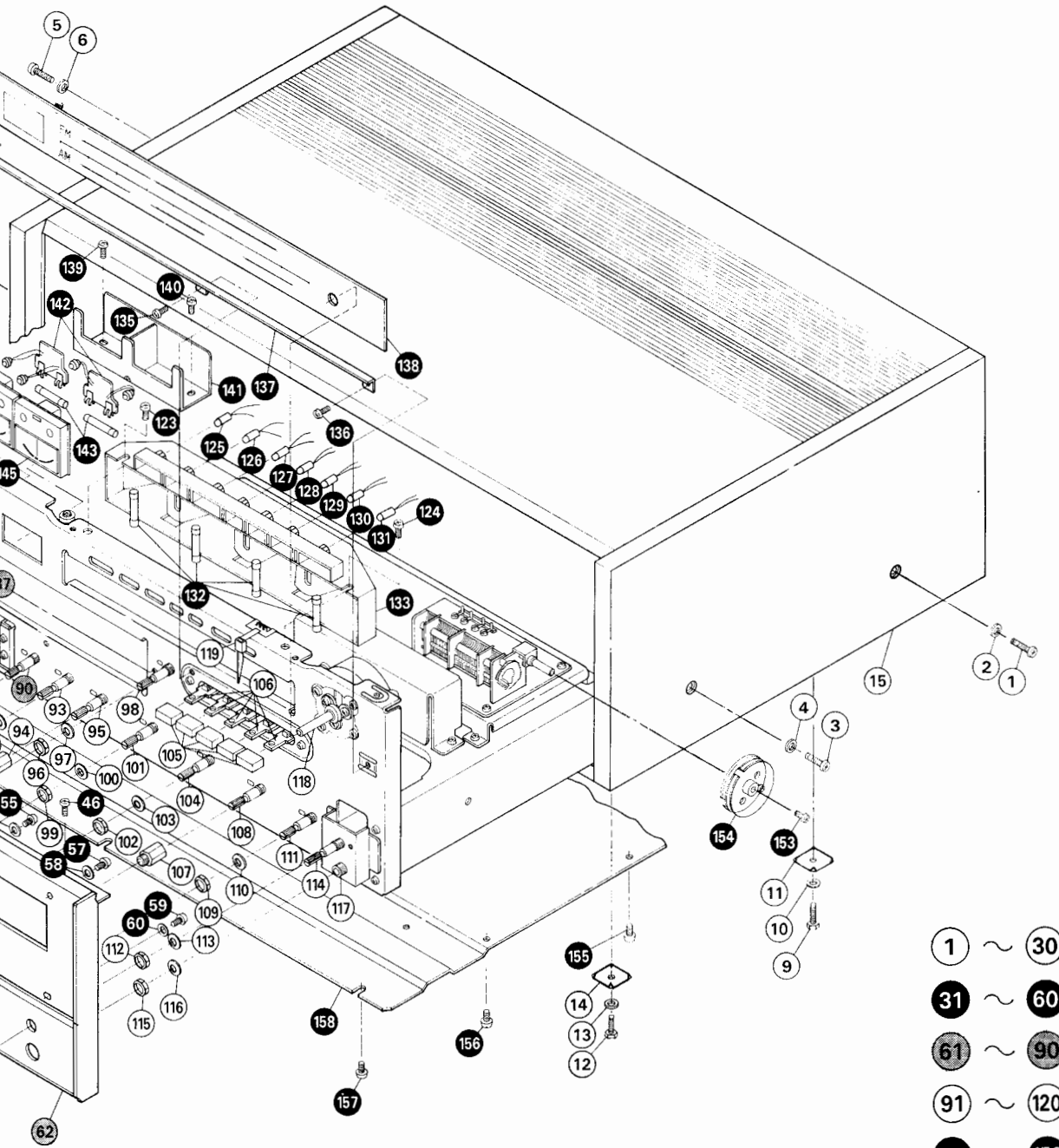


Parts List

Parts No.	Stock No.	Description
1	5100173	Binding Head Screw, M4 × 25
2	5186110	Plain Washer, 4φ
3	5100173	Binding Head Screw, M4 × 25
4	5186110	Plain Washer, 4φ
5	5100173	Binding Head Screw, M4 × 25
6	5186110	Plain Washer, 4φ
7	5100173	Binding Head Screw, M4 × 25
8	5186110	Plain Washer, 4φ

Parts No.	Stock No.	Description
9	5104571	Hexagon Head Bolts, M4 × 23
10	5121260	Spring Washer, 4φ
11	5186091	Nail Washer
12	5104571	Hexagon Head Bolts, M4 × 23
13	5121260	Spring Washer, 4φ
14	5186091	Nail Washer
15	5726820	Wood Case
16	5317671	WO-1 Type Knob, BASS volume

Parts No.
17
18
19
20
21
22
23
24



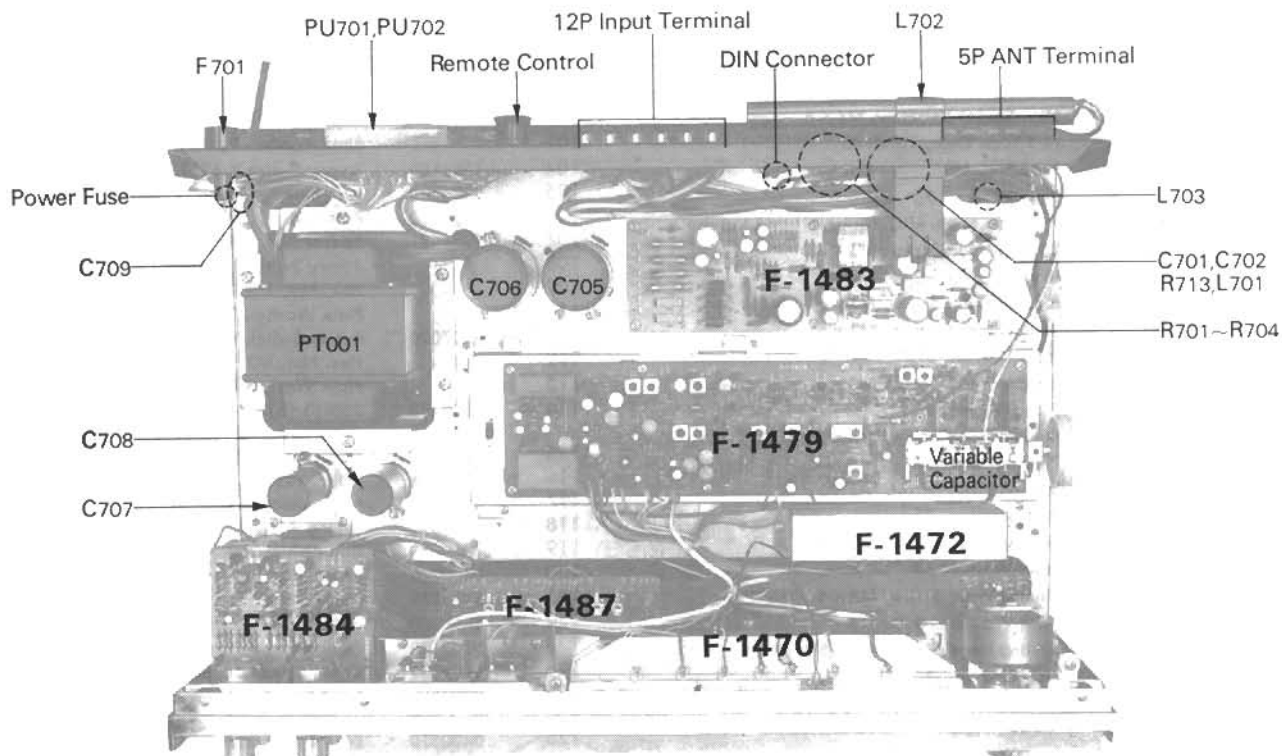
- 1 ~ 30
- 31 ~ 60
- 61 ~ 90
- 91 ~ 120
- 121 ~ 158

Parts No.	Stock No.	Description
17	5317682	WI-1 Type Knob, BASS volume
18	5317671	WO-1 Type Knob, BASS volume
19	5317682	WI-1 Type Knob, BASS volume
20	5317671	WO-1 Type Knob, TREBLE volume
21	5317682	WI-1 Type Knob, TREBLE volume
22	5317671	WO-1 Type Knob, TREBLE volume
23	5317682	WI-1 Type Knob, TREBLE volume
24	5176052	Jack Nut

Parts No.	Stock No.	Description
25	5176052	Jack Nut
26	5317642	M-2 Type Knob, SPEAKER switch
27		Hex. Nut, M9
28		Plain Washel, 9φ
29	5317652	S-2 Type Knob, BALANCE volume
30	5317652	S-2 Type Knob, BALANCE volume
31	5317652	S-2 Type Knob, BALANCE volume
32		Hex. Nut, M9

Parts No.	Stock No.	Description	Parts No.	Stock No.	Description
33		Plain Washer, 9φ	96		Hex. Nut, M8
34	5317811	P-5 Type Knob, LEVEL SET volume	97		Plain Washer, 8φ
35	5317632	L-2 Type Knob, VOLUME	98	1060260, 1	250kΩ (B) × 4 LEVEL SET Volume
36	5317642	M-2 Type Knob, FUNCTION switch	99		Hex. Nut, M9
37	5317642	M-2 Type Knob, DIRECTION switch	100		Plain Washer, 9φ
38	5317642	M-2 Type Knob, SELECTOR switch	101	1060240, 1	250kΩ (B) × 4 VOLUME
39	5106061	Hex. Socket Setscrew, M4 × 6	102		Hex. Nut, M9
40	5317780	N-5 Type Knob, TUNING	103		Plain Washer, 9φ
41		Hex. Nut, M9	104	1106120	Rotary Switch Y-6217, FUNCTION switch
42		Plain Washer, 9φ	105	5326380	Push Button, accessory switch
43	5317811	P-5 Type Knob, MIC. MIXING LEVEL volume	106	1130750	Push Switch (5 Stage)
44	5101043	Binding Head Screw, M3 × 6	107	5236491	Spacer Nut, M9
45	5101043	Binding Head Screw, M3 × 6	108		Rotary Switch Y-244, DIRECTION switch
46	5101043	Binding Head Screw, M3 × 6	109		Hex. Nut, M9
47	5101042	Binding Head Screw, M3 × 5	110		Plain Washer, 9φ
48	5120141	Plain Washer, 3φ	111	1107020	Rotary Switch Y-7177, SELECTOR switch
49	5101042	Binding Head Screw, M3 × 5	112		Hex. Nut, M7
50	5120141	Plain Washer, 3φ	113		Plain Washer, 7φ
51	5101042	Binding Head Screw, M3 × 5	114	1060280	250kΩ (B) × 2, 50kΩ (B) × 2 MIC, MIXING LEVEL Volume
52	5120141	Plain Washer, 3φ	115		Hex. Nut, M12
53	5101042	Binding Head Screw, M3 × 5	116		Plain Washer, 12φ
54	5120141	Plain Washer, 3φ	117	2430170	Microphone Jack
55	5101042	Binding Head Screw, M3 × 5	118	7036361	Tuning Ass'y
56	5120141	Plain Washer, 3φ	119		Dial Pointer Ass'y
57	5101042	Binding Head Screw, M3 × 5	120	0400200	Pilot Lamp, lead type (6.3V 75mA)
58	5120141	Plain Washer, 3φ	121	5416050	Dial Pointer
59	5101042	Binding Head Screw, M3 × 5	122	5416300	Holder, dial pointer
60	5120141	Plain Washer, 3φ	123	5109122	Binding Head Tapping Screw, M3 × 8
61	5308891	Smoked Plate Frame	124	5109122	Binding Head Tapping Screw, M3 × 8
	5047680	Smoked Plate	125	0400300	Lead Type Lamp (7V 100mA), STEREO indicator
62	7006902	Front Panel	126	0400310	Lead Type Lamp (7V 100mA), PHONO-2 indicator
63	7106083	Push Button, POWER switch	127	0400330	Lead Type Lamp (7V 100mA), PHONO-1 indicator
64	6906031	Spring, POWER switch	128	0400300	Lead Type Lamp (7V 100mA), FM indicator
65		Hex. Nut, M11	129	0400290	Lead Type Lamp (7V 100mA), AM indicator
66		Plain Washer, 11φ	130	0400320	Lead Type Lamp (7V 100mA), AUX-1 indicator
67	1020240, 1	100kΩ (B) × 2 BASS Volume	131	0400310	Lead Type Lamp (7V 100mA), AUX-2 indicator
68		Hex. Nut, M11	132	0420040	Fuse Type Lamp (7V 300mA)
69		Plain Washer, 11φ	133	5066211	Indicator Box
70	1020240, 1	100kΩ (B) × 2 BASS Volume	134	5109122	Binding Head Tapping Screw, M3 × 8
71		Hex. Nut, M11	135	5109122	Binding Head Tapping Screw, M3 × 8
72		Plain Washer, 11φ	136	5109122	Binding Head Tapping Screw, M3 × 8
73	1020250, 1	100kΩ (W) × 2 TREBLE Volume	137	5269240	Stopper, dial scale
74		Hex. Nut, M11	138	5407510	Dial Scale
75		Plain Washer, 11φ	139	5109122	Binding Head Tapping Screw, M3 × 8
76	1020250, 1	100kΩ (W) × 2 TREBLE Volume	140	5109122	Binding Head Tapping Screw, M3 × 8
77	1130290	Push Switch, POWER switch	141	5269250	Holder, tuning & signal meter
78		Hex. Nut, M9	142	7726050	Meter Lamp Unit
79		Plain Washer, 9φ	143	0420040	Fuse Type Lamp (7V 300mA)
80		Hex. Nut, M9	144	4300610	Signal Meter
81		Plain Washer, 9φ	145	4300600	Tuning Meter
82	2430200	Headphone Jack	146	5109122	Binding Head Tapping Screw, M3 × 8
83	5236491	Spacer Nut, M9	147	5109122	Binding Head Tapping Screw, M3 × 8
84	1102500, 1	Rotary Switch Y-224, 244, SPEAKER switch	148	5109122	Binding Head Tapping Screw, M3 × 8
85	5326380	Push Button, LOW & HIGH FILTER switch	149	5269250	Holder, level meter
86	1130760	Push Switch (2 Stage)	150	0420040	Fuse Type Lamp (7V 300mA)
87	1130760	Push Switch (2 Stage)	151	7726050	Meter Lamp Unit
88		Hex. Nut, M8	152	4300620	Level Meter
89		Plain Washer, 8φ	153	5101123	Binding Head Screw, M2, 6 × 6
90	1010400, 1	250kΩ (HB) BALANCE Volume	154	6146651	Dial Pulley
91		Hex. Nut, M8	155	5101161	Binding Head Screw, M4 × 6
92		Plain Washer, 8φ	156	5101161	Binding Head Screw, M4 × 6
93	1060250, 1	250kΩ (HB) × 4 BALANCE Volume	157	5101161	Binding Head Screw, M4 × 6
94	5236461	Spacer Nut, M8	158	5058100	Bottom Plate
95	1010400, 1	250 (HB) BALANCE Volume			

6-15. Other Parts (Top Side)



Top Side Parts List

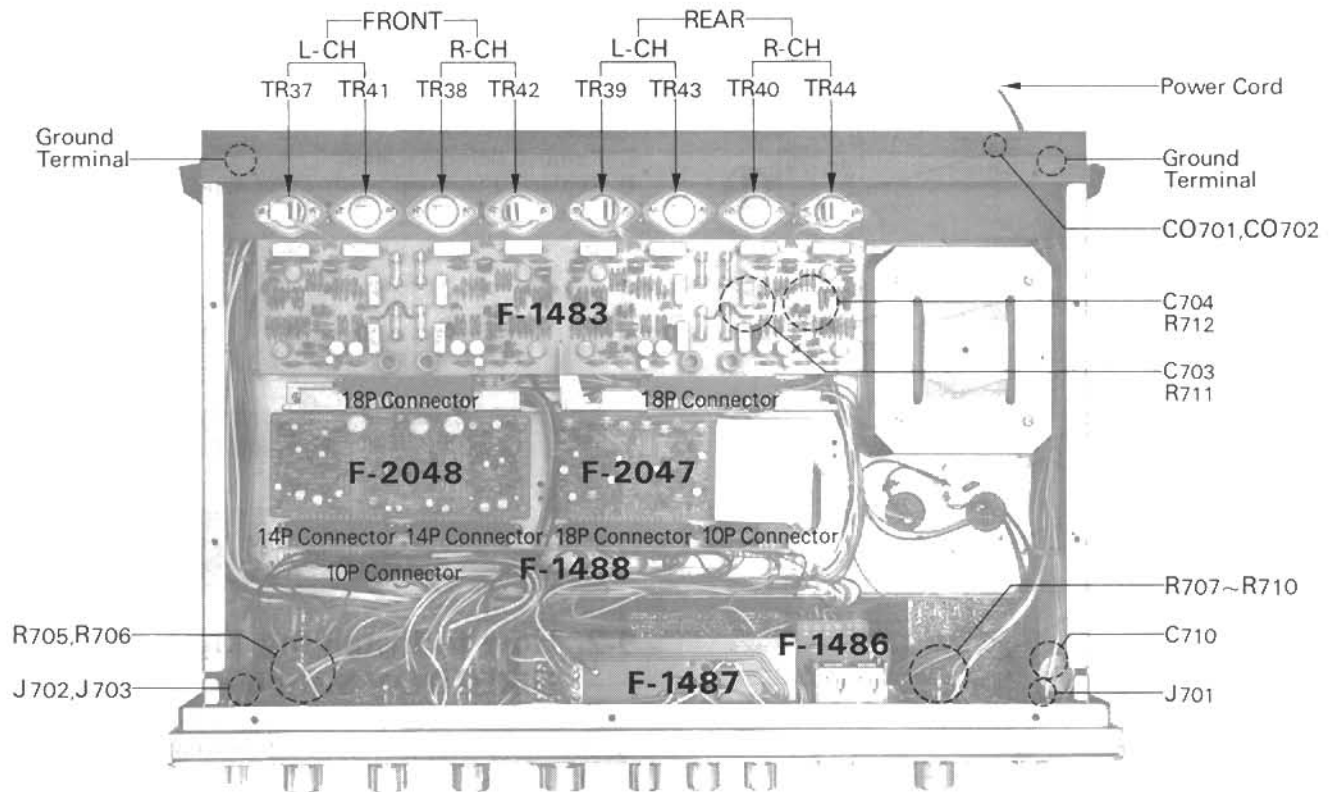
Parts No.	Stock No.	Description
C701	0657473	0.047 μ F } 50V C.C.
C702	0657473	0.047 μ F }
C705	0559107	10000 μ F 35V } E.C.
C706	0559107	10000 μ F 35V }
C707	0559501	1000 μ F 63V }
C708	0559501	1000 μ F 63V }
C709	0605477	0.047 μ F 250V M.C.
R701	0107104	100k Ω } $\pm 5\%$ $\frac{1}{4}$ W C.R.
R702	0107184	180k Ω }
R703	0107184	180k Ω }
R704	0107104	100k Ω }
R713	0107221	220 Ω }
L701	4290030	1 μ H Coil
L702	4200550	Bar Antenna Coil
L703	4290021	75 Ω : 300 Ω FM Balun
F701	{ 2300060	Fuse Holder
	{ 0431290, 2	6A Power Fuse (100V, 117V)
	{ 0431310	3.5A Power Fuse (220V, 240V)

Parts No.	Stock No.	Description
PU701	2410090	Voltage Selector, plug
PU702	2410080	Voltage Selector, socket
PT001	4001360	Power Transformer
	2430040	DIN Connector
	2010020	9P Remote Control Socket
	2410540	9P Remote Control Dummy Plug
	2290110	5P Antenna Terminal
	2200360	12P Input Terminal

Abbreviations

C.R.	: Carbon Resistor	BP.E.C.:	Bi-Pola Electrolytic Capacitor
S.R.	: Solid Resistor	C.C.	: Ceramic Capacitor
Ce.R.	: Cement Resistor	Mi.C.	: Mica Capacitor
M.R.	: Metallized Film Resistor	O.C.	: Oil Capacitor
M.C.	: Mylar Capacitor	P.C.	: Polystyrene Capacitor
E.C.	: Electrolytic Capacitor	T.C.	: Tantalum Capacitor

6-16. Other Parts (Bottom Side)



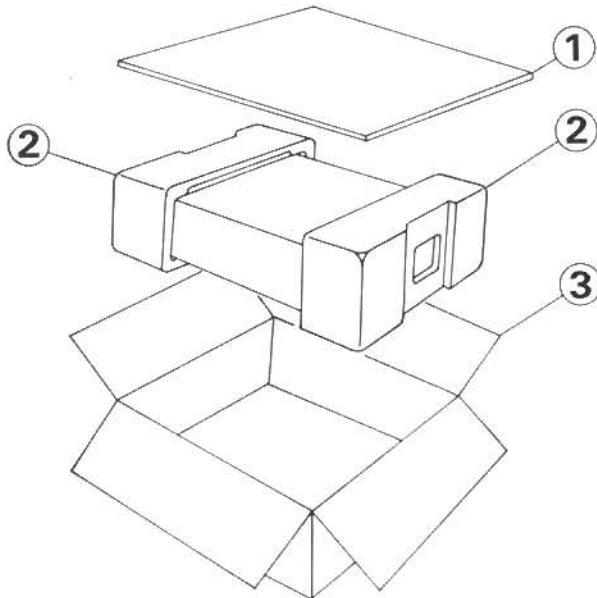
Bottom Side Parts List

Parts No.	Stock No.	Description
TR37	0305631	2SC1030 (B)
TR38	0305631	2SC1030 (B)
TR39	0305631	2SC1030 (B)
TR40	0305631	2SC1030 (B)
TR41	0300551	2SA756 (B)
TR42	0300551	2SA756 (B)
TR43	0300551	2SA756 (B)
TR44	0300551	2SA756 (B)
		Transistor
C703	0659011	0.01 μ F 500V
C704	0659011	0.01 μ F 500V
C710	0659801	0.01 μ F 1.4kV
		C.C.
R705	0107473	47k Ω
R706	0107473	47k Ω
		$\pm 5\%$ $\frac{1}{4}$ W C.R.
R707	0172331	330 Ω
R708	0172331	330 Ω
R709	0172331	330 Ω
R710	0172331	330 Ω
R711	0172562	5.6k Ω
R712	0172562	5.6k Ω
		2W M.R.

Parts No.	Stock No.	Description
CO701,702	2450040	AC outlet
J701	2430170	Microphone Jack
J702	2430200	Headphone Jack
J703	2430200	Headphone Jack
	3800020	KP-200 Power Cord
	2420030	10P Connector
	2420150	14P Connector
	2420020	18P Connector
	2230050	Ground Terminal

7. PACKING LIST

Parts No.	Stock No.	Description
1	9017310	Inner Packing
2	9027750	Styrofoam Packing
3	9007511	Carton Case



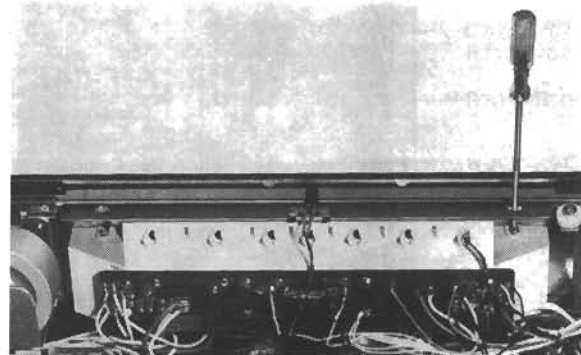
8. ACCESSORY PARTS LIST

Stock No.	Description
9406020	Polishing Cloth
0433680	3.5A Quick Acting Fuse
3820040	AM/FM Antenna
9207610	Operating Instruction
9227610	Operating Instruction Sheet

9. REPLACEMENT OF MAIN PARTS

9-1. Dial Lamp

- 1) Remove wood bonnet.
- 2) Insert a screwdriver into hole on upper side of back panel and loosen two screws, then remove reflector box.
- 3) Remove defective lamp.
- 4) Replace the lamp with same type of 7V 300mA Fuse Type Lamp.



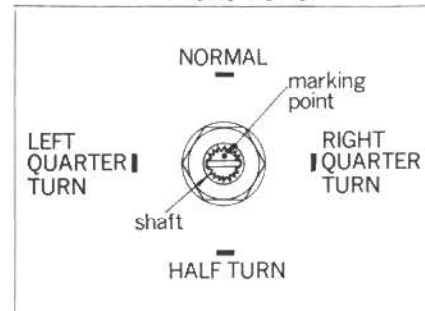
9-2. How to Install the Knob of DIRECTION Switch

In case of re-installation of the knob after servicing on this unit, please perform the following method correctly.

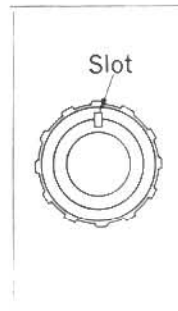
- 1) Meet a marking point (Fig. 9-1) on top of the shaft and the knob's slot (Fig. 9-2).

Fig. 9-1

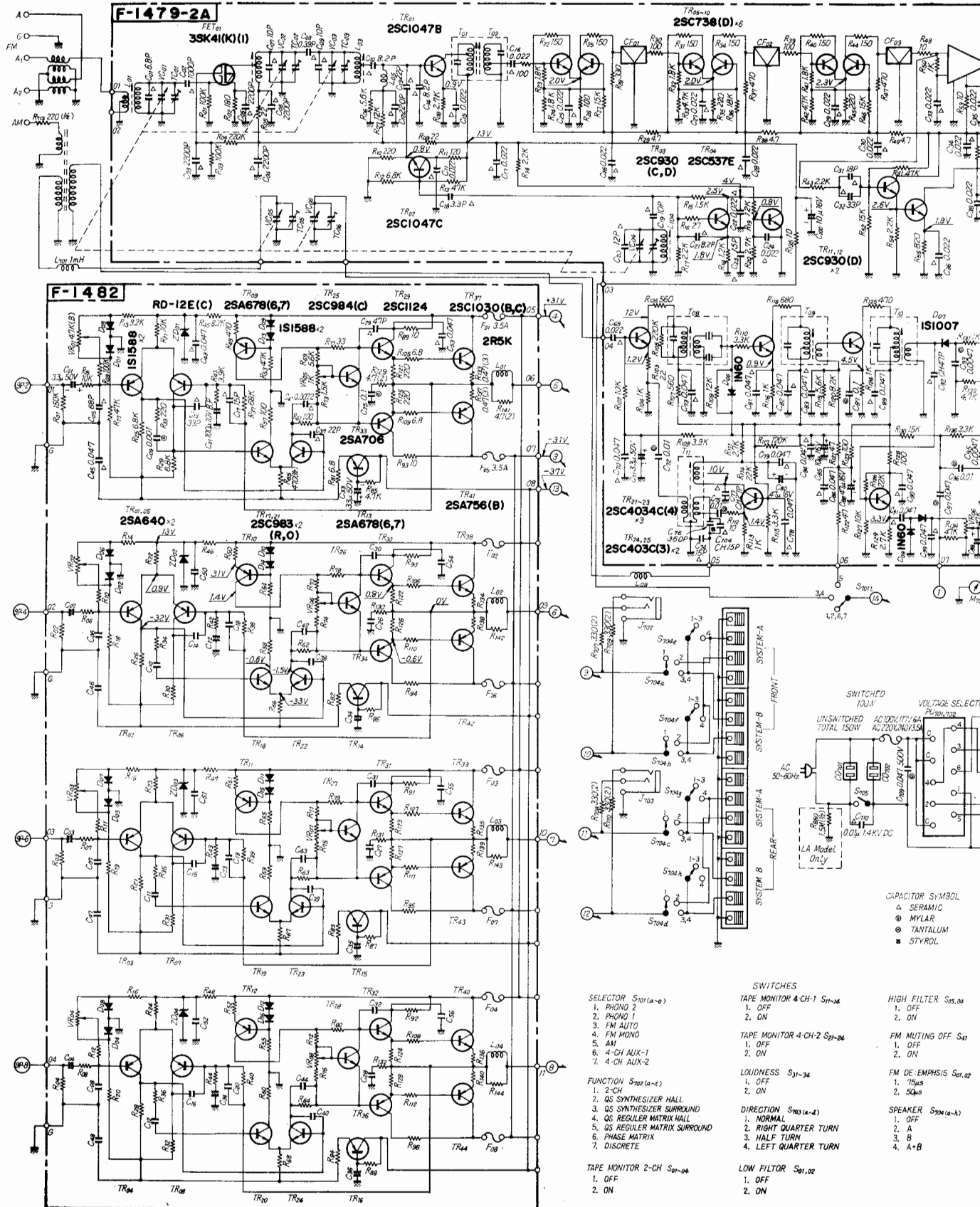
Front Panel



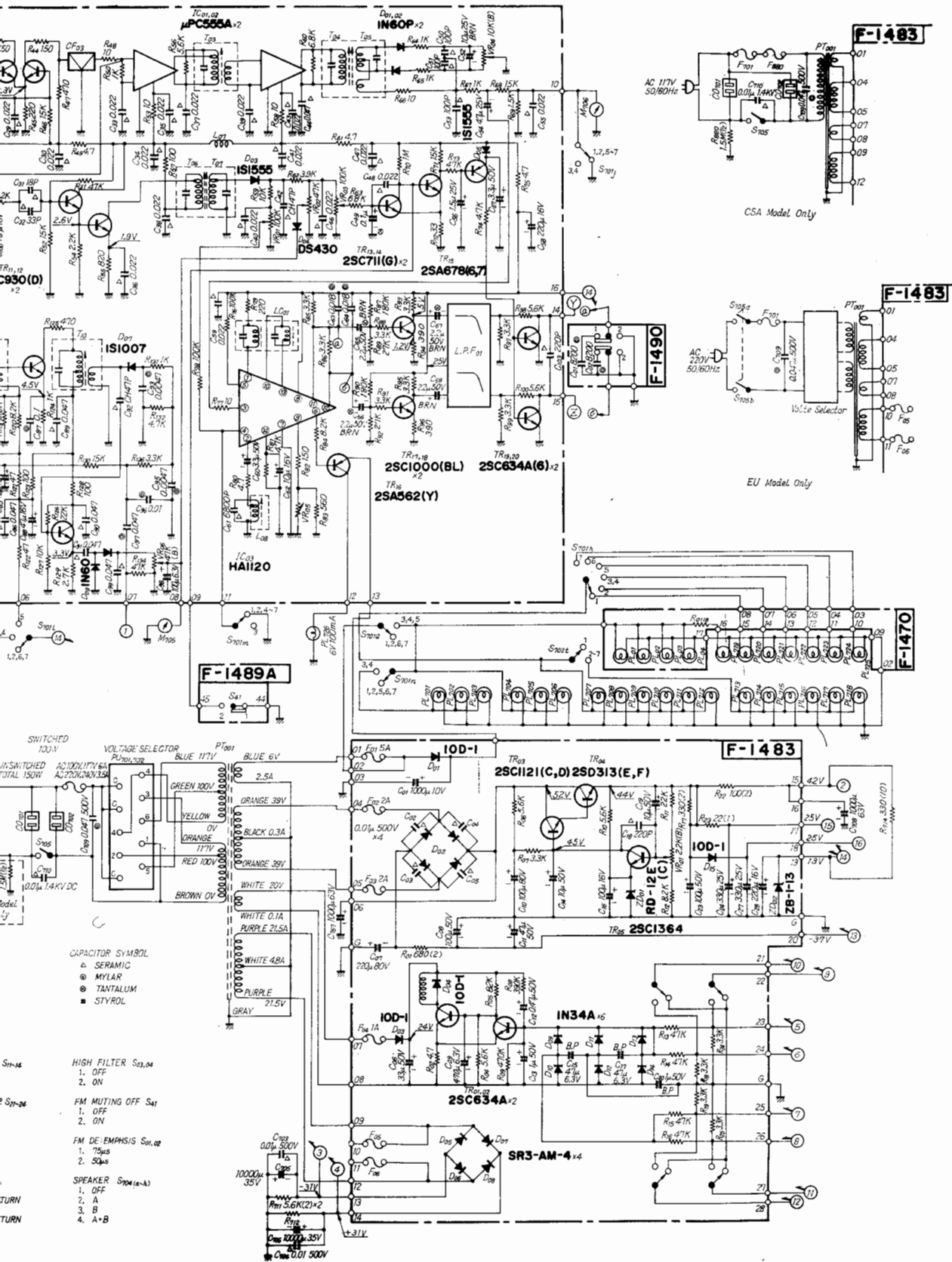
Fi.g 9-2



10. SCHEMATIC DIAGRAM OF TUNER SECTION

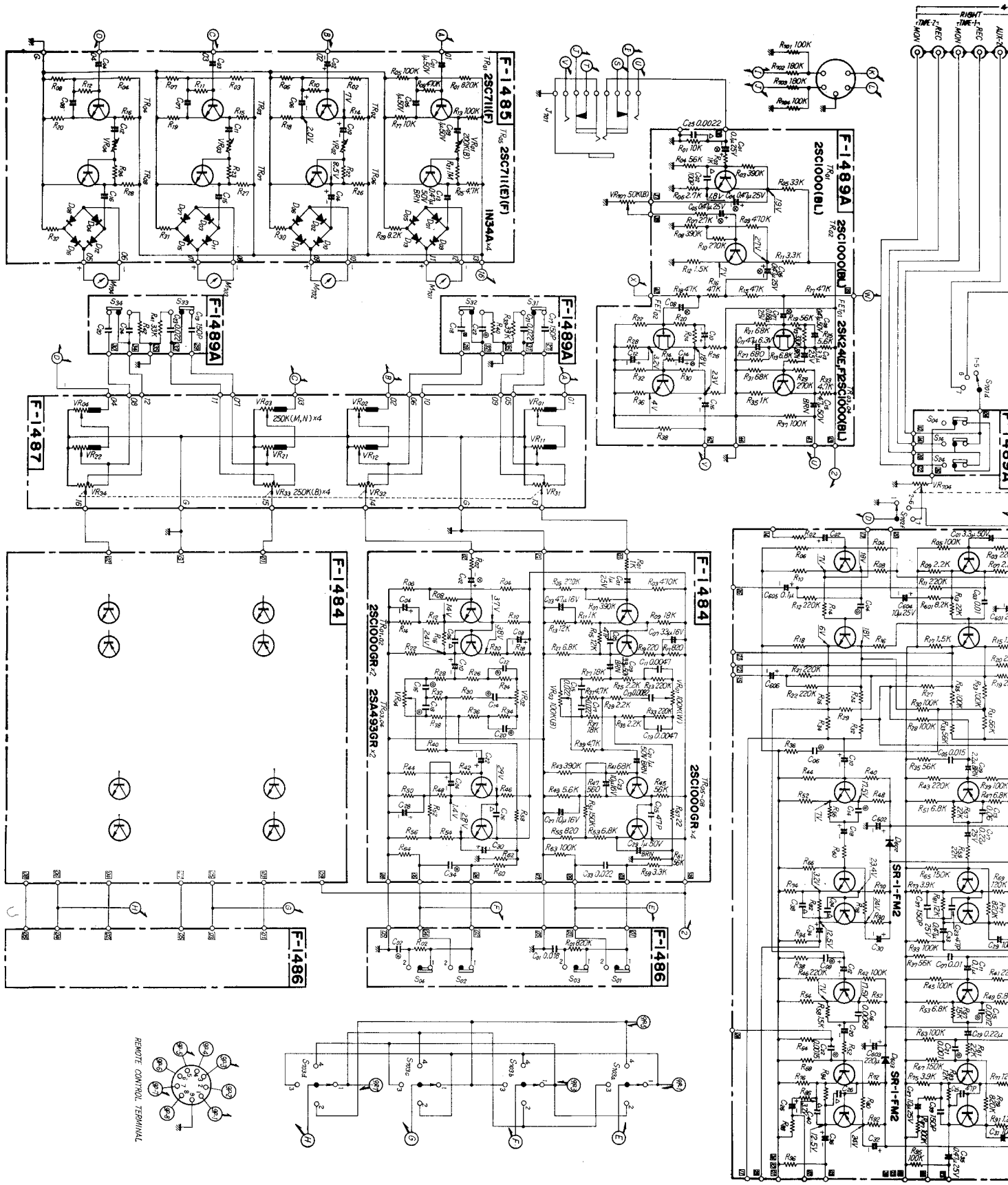


* Design and specifications subject to change without notice for improvements.

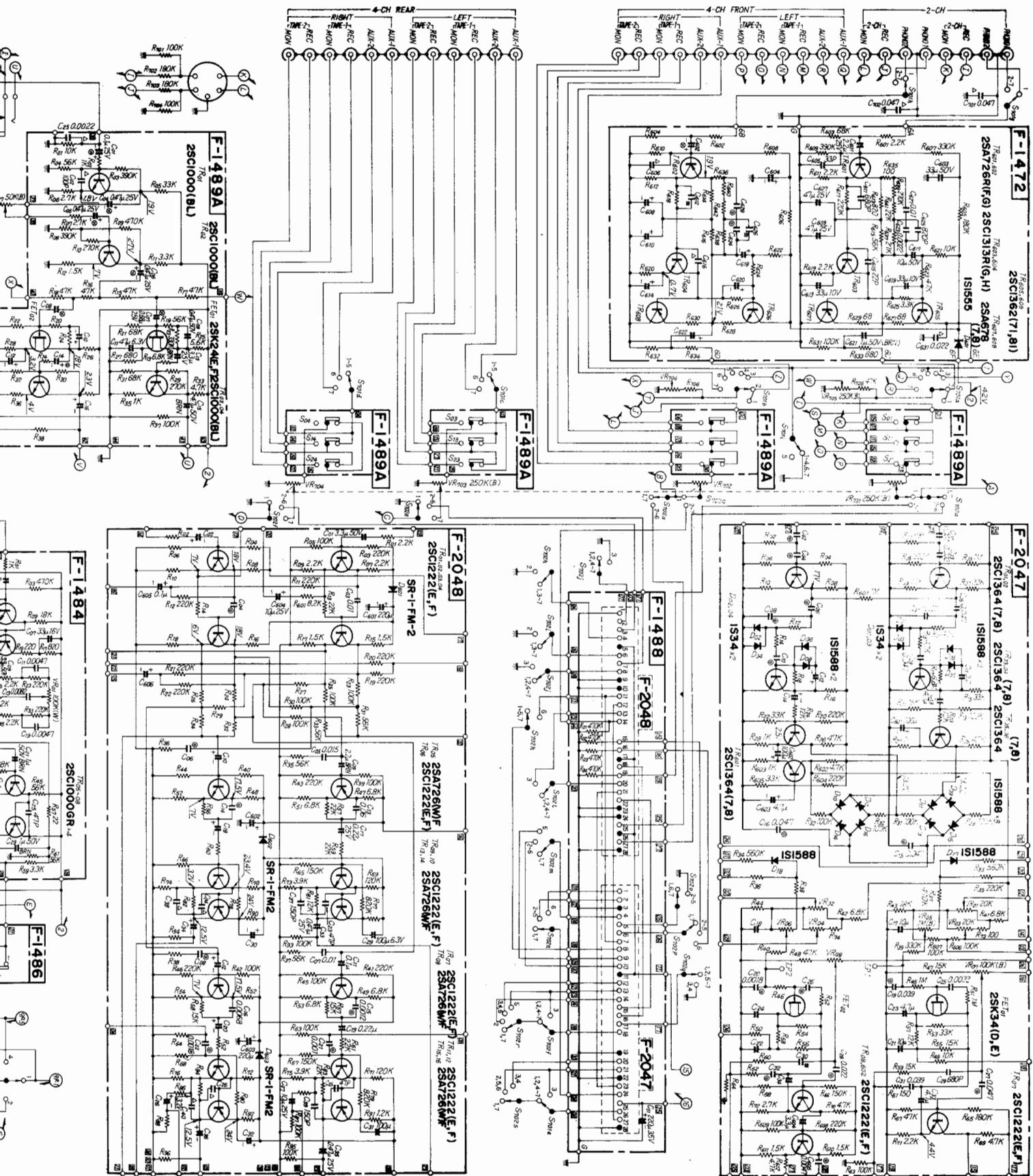


11. SCHEMATIC DIAGRAM OF AUDIO SECTION

* Design



* Design and specifications subject to change without notice for improvements.



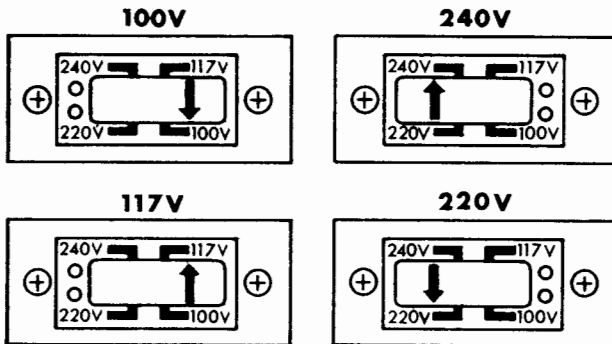
12. MAINTENANCE

12-1. Voltage Adjustment

The Voltage Selector on the rear panel enables you to operate at correct voltage in any areas. The voltage has been preadjusted at the factory, but can be easily changed as follows, according to the line voltage using in your area.

- 1) Remove the two screws securing the name plate on the unit's rear panel, then remove the name plate.
- 2) Unplug the Voltage Selector plug once, and reset it so that the arrow mark on it faces the correct voltage indication. Also change the power fuse when the power supply voltage has change. For 100/117 volt operation, use a 6-ampere glass-tubed fuse. For 220/240 volt operation, use a 3.5-ampere one.

Note: The Voltage Selector can be used to eliminate the trouble caused by the considerable voltage fluctuation. In this case, it should be set to the peak voltage.





SANSUI ELECTRIC CO., LTD.

14-1, 2-chome, Izumi, Suginami-ku, Tokyo 168, Japan.
TELEPHONE: (03) 323-1111/TELEX: 232-2076